

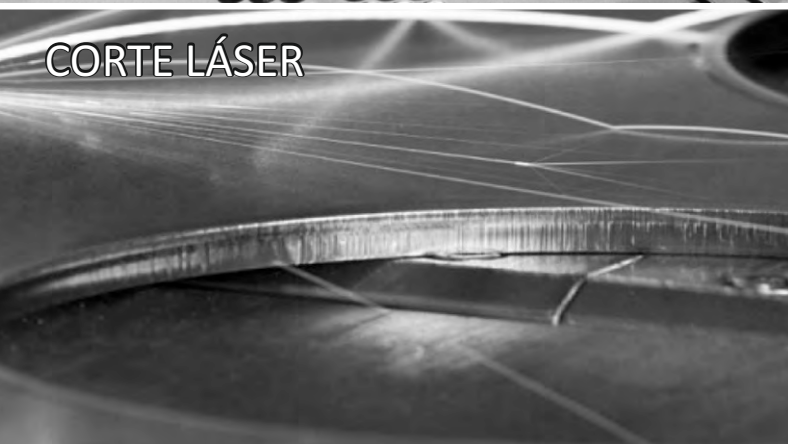

Maquinaria y utillaje para el corte  
y la deformación de la chapa

Be different!  
Be Supraform!

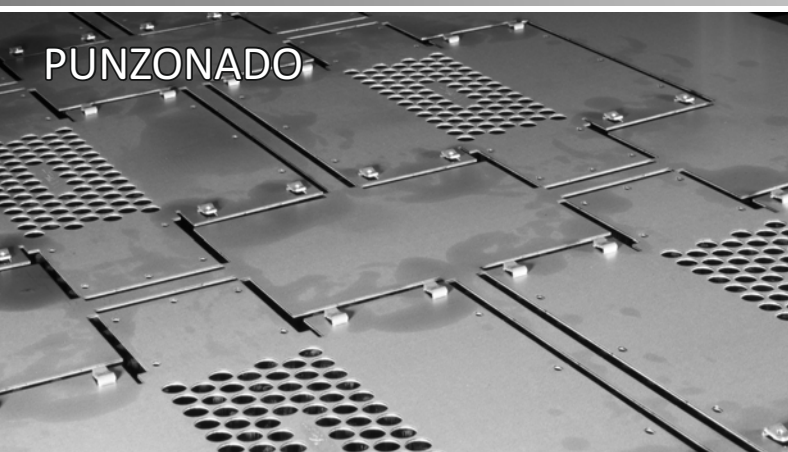

Be different!  
Be Supraform!

25

**SUPRAFORM**

1996 - 2021  
Be different Be Supraform

*Más de 25 años aportando soluciones  
para el corte y la deformación de la chapa*





Herramientas para todas las marcas de punzonadora  
Finn-Power - Amada - Trumpf - Goiti - LVD - Euromac  
Rainer - Boschert- Technology - Haco

## Herramientas de Torreta



**EXP**

## Multitools Herramientas de Corte





Herramientas para todas las marcas de punzonadora  
Finn-Power - Amada - Trumpf - Goiti - LVD - Euromac  
Rainer - Boschert- Technology - Haco

Herramientas  
tipo **Trumpf**



Herramientas  
Multipunzón  
Multitools





Ofrecemos la más amplia gama de herramientas especiales para punzonadoras CNC  
AMADA, TRUMPF, FINN-POWER, GOITI, EUROMAC, otras

## Herramientas Especiales

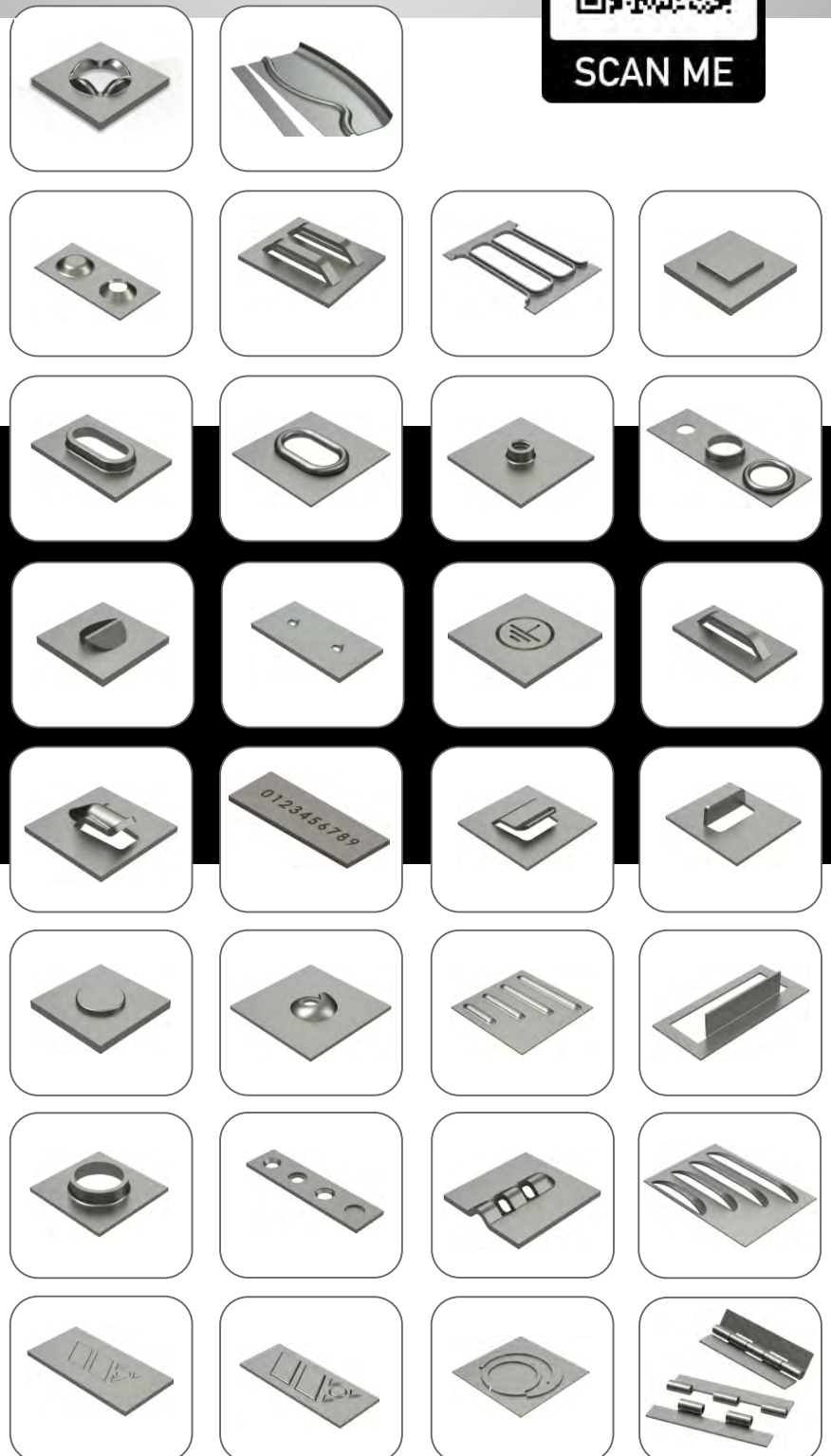



Útiles para cualquier plegadora  
100% compatibles con original garantizado



Útiles y accesorios  
para Plegadoras

Sistemas: Trumpf - Wila - Bystronic - Promecam



Soluciones  
Accesorios y complementos

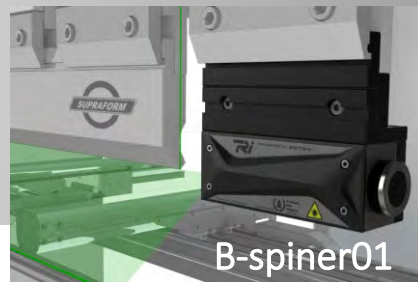

Alineación láser  
rápida y precisa

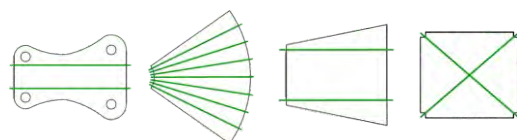

Útiles especiales y accesorios  
 para **Plegadoras**

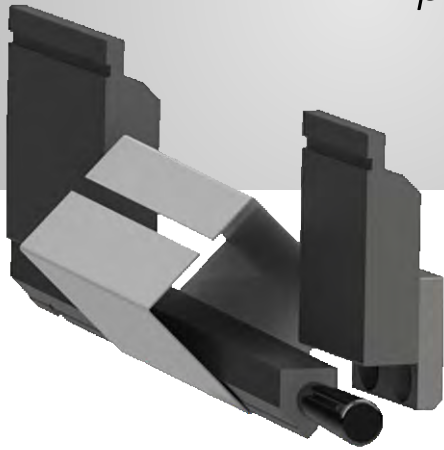

**toolspress**

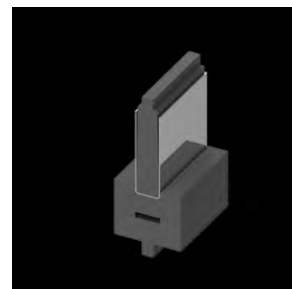
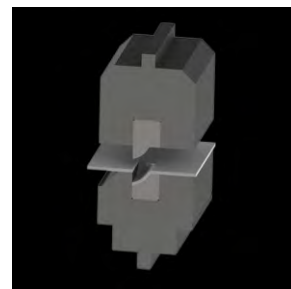
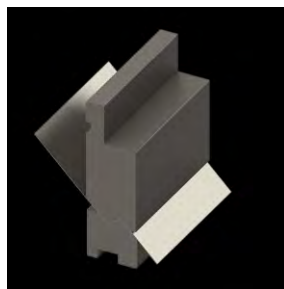
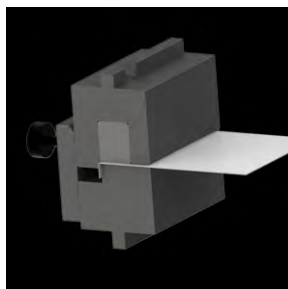
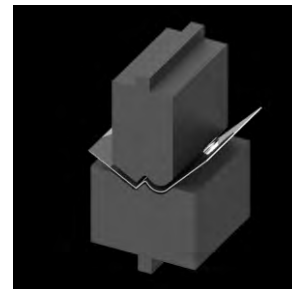
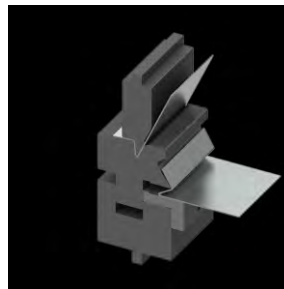

*Soluciones de plegado  
 sin marcas ni deformaciones*



*Matrices  
 V-series Black*



Unidades, sistemas y líneas de punzonado  
automáticas y semi automáticas

Sistemas de punzonado  
alta **Productividad**



**SUPRAPUNCH**

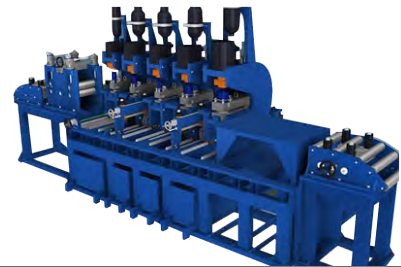
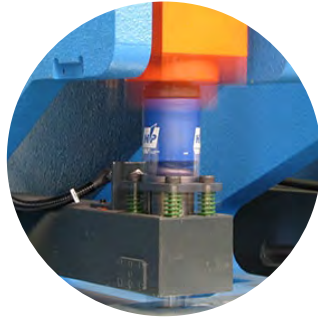

Unidades de corte y punzonado  
para **chapa y tubo**

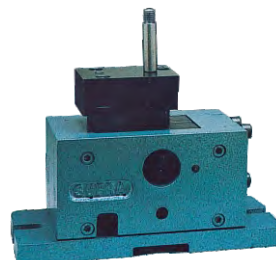
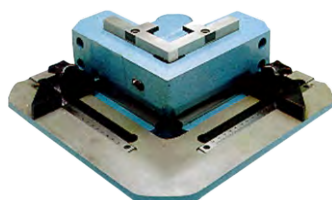
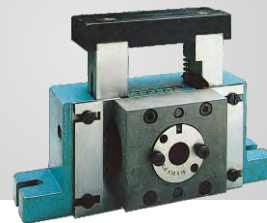





**Hypertherm**  
Centricut

Consumible y recambios para máquinas láser de fibra y CO2



Consumibles  
para Fibra - CO2

Boquillas - cerámicas - lentes - espejos - vitrinos - kits de limpieza - filtros - líquidos



Entregas  
en 24-48h

Variedad  
de Accesorios





## Mecanismos de elevación y manipulación por vacío para el transporte horizontal y vertical de la chapa

Aparatos para el transporte  
Manipulación de la chapa



### Elevación por vacío

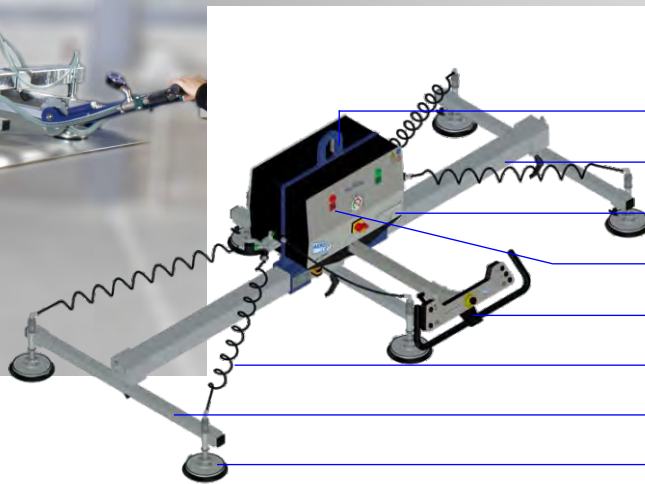
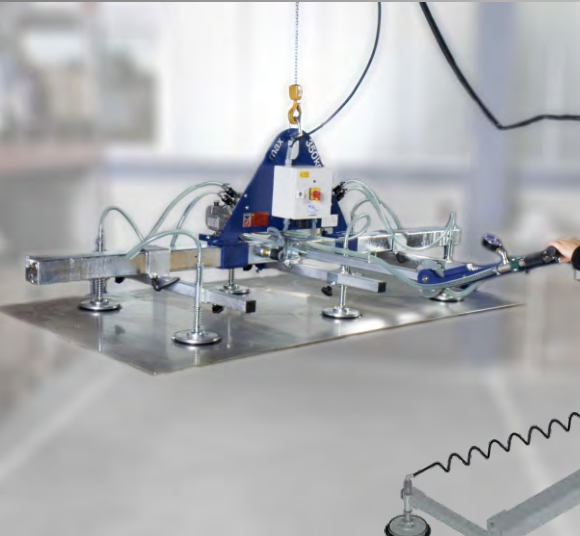

- Argolla de anclaje
- Travesaño principal / Acumulador de vacío
- Caja de distribución con bomba de vacío
- Luces de advertencia - seguridad
- Panel de control orientable
- Mangueras de vacío
- Travesaño regulable
- Ventosas de succión ajustables



- Unidad de transporte horizontal rígida para manipular chapa.
- Capacidades de carga entre 100 kg y 2000 kg.
- Circuito de vacío simple con acumulador de hasta 25 litros.
- Mango multifunción en ángulo con control de grúa (sólo modelo ADVANCE).
- Avisador óptico-acústico con vacuómetro de serie.
- Suspensiones en la placa de succión accionadas por resorte.

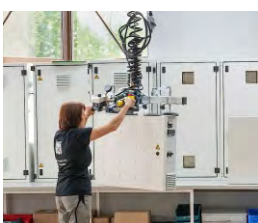



Herramientas portátiles para máquinas de corte láser y plegadoras convencionales

Limpiador  
de Parrillas láser



The Unicorn  
Martillo percutor



El martillo percutor para la extracción de piezas metálicas de sus microsujeciones

Móvil, seguro, ergonómico  
Brazo acompañador



- Su diseño con ruedas, permite montaje rápido en cualquier plegadora
- Aumenta la seguridad, eficiencia, ergonomía, productividad y fluidez
- Ideal para paneles, piezas grandes y/o pesadas
- Reduce errores, mano de obra, riesgos, lesiones y espacio



# Máquinas punzonadoras Eléctricas CNC

Equipos de punzonado  
Eléctricos

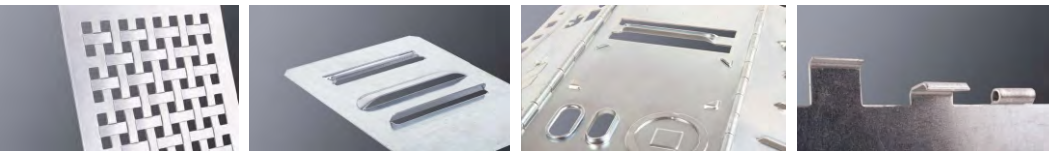

# Maquinaria para la fabricación de conductos de ventilación

Máquinas para  
Bordonado y perfilado

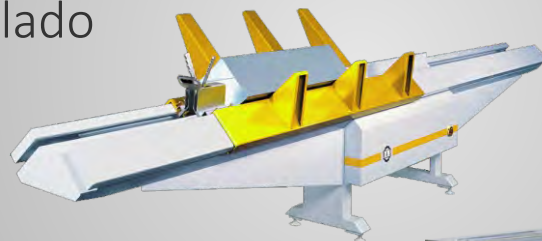



cizallas  
circulares

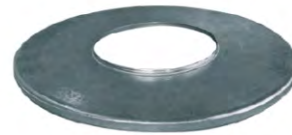
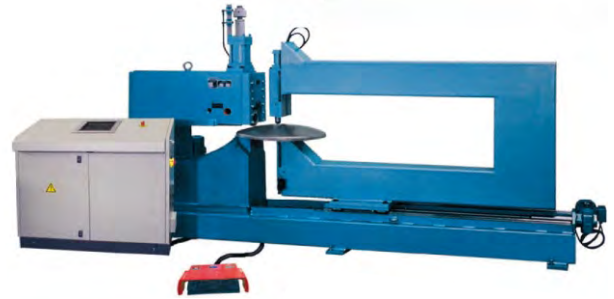

*Equipos de soldadura  
soldaduras perfectas en una sola pasada*



*Soldadura de tubos  
ventilación - aspiración*

*Soldadura de esquinas  
Cuadros eléctricos, mobiliario metálico...*

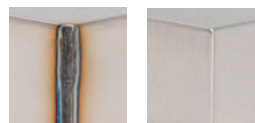



Equipos de plegado  
100% Eléctricos

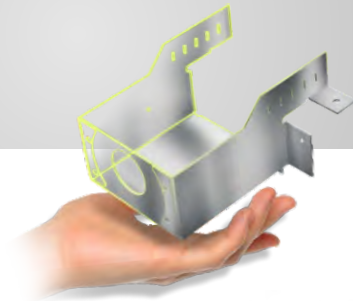

**AUTOPOL** 



Cambio de útiles  
automático

Robotizado  
Células de plegado

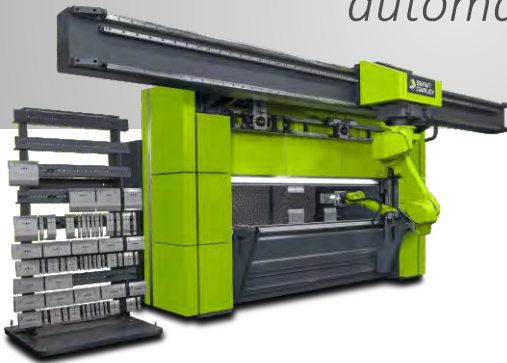

Cizallas  
Corte de alta precisión





# Paneladoras automáticas y semi-automáticas

## XLT Bend

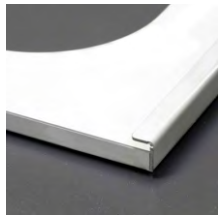
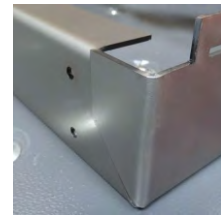
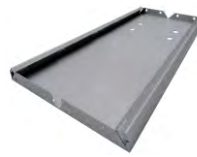
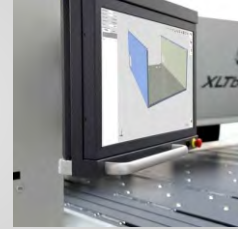
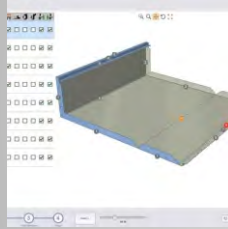

## UpDown Center

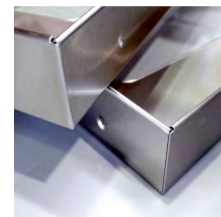

## Multibend Center

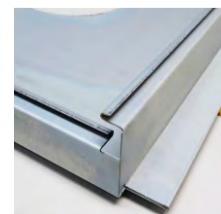
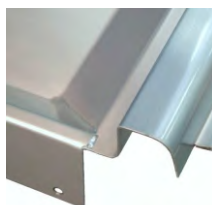



# Centros de punzonado y corte eléctricos para chapa en bobina

Equipos de corte  
punzonado, corte, plegado y panelado



- Apilado automático de piezas
- Módulos de cizalla transversal y longitudinal

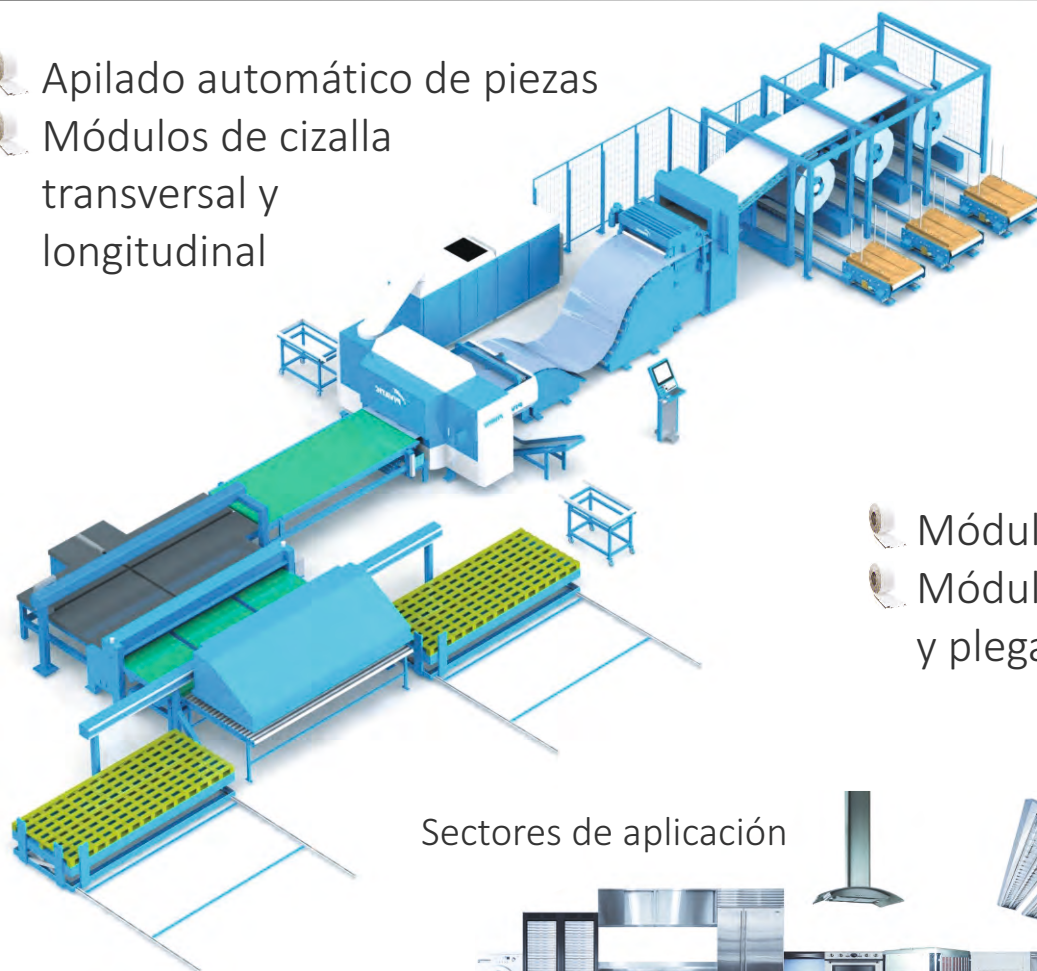

- Módulos de punzonado
- Módulos de panelado y plegado

Sectores de aplicación



Nesting de bobina

Fabricación bajo pedido tipo kit

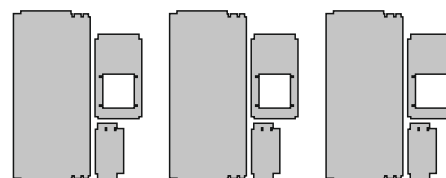

Producción en lotes (método tradicional)

Producción con eficiencia de material tipo Kit

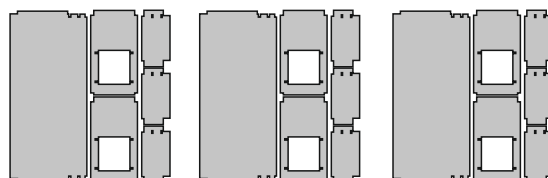
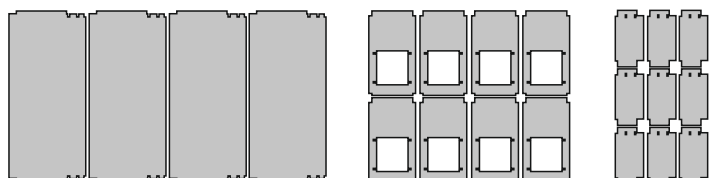





*Líneas automáticas de punzonado y panelado*

*Líneas de producción Automáticas*

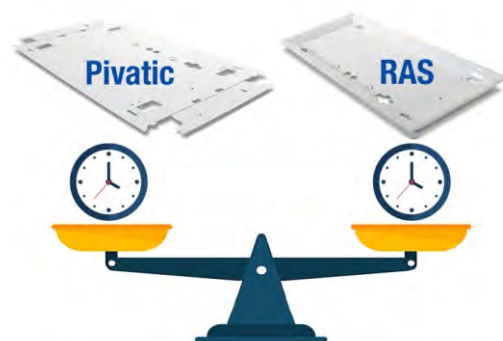
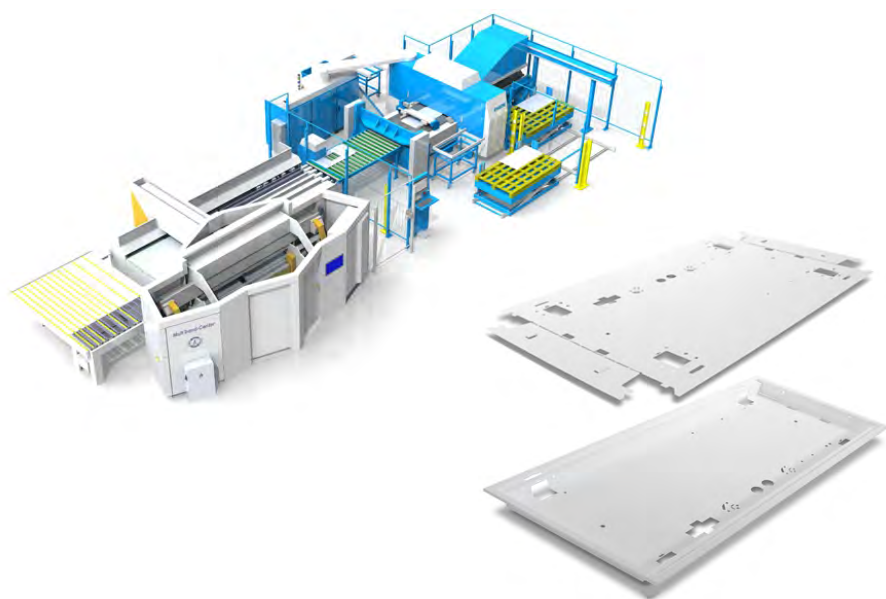

**Punzonado = Plegado**

*Sistemas de Producción*

*Máxima eficiencia energética, totalmente eléctrica, aprovechamiento de chapa, mínimos tiempos muertos, altamente productivas*

**Devanadora/Bobina**

**Punzonado/Corte**

**Volteo/Rotación**

**Plegado/Panelado**

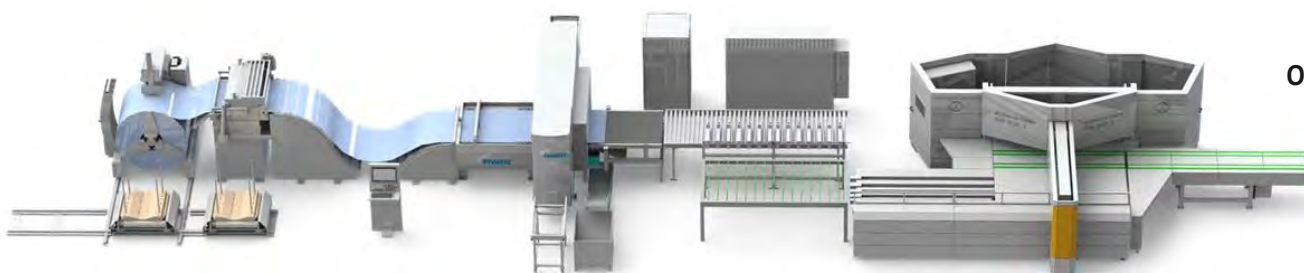

**OTROS PERIFÉRICOS:**

- Descarga paletizada
- Soldadura
- Perfilado...

**Carga desde formato**

**Punzonado/Corte**

**Volteo/Rotación**

**Plegado/Panelado**



**OTROS PERIFÉRICOS:**

- Descarga paletizada
- Soldadura
- Perfilado...



# JORNS

Centros de plegado automáticos para la fabricación de remates y perfiles de chapa

## XXL Center

Centros de plegado  
Positivo - Negativo

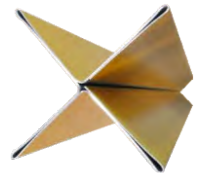
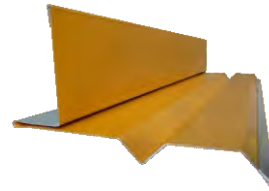
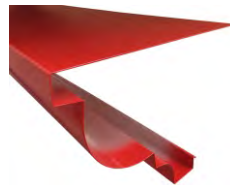
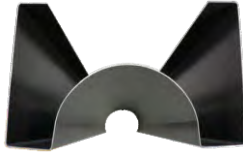
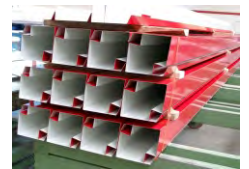
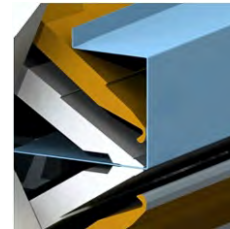
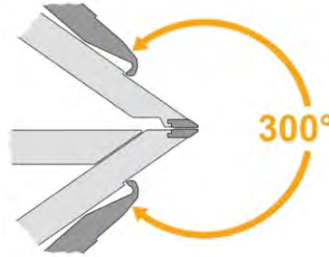
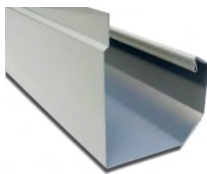
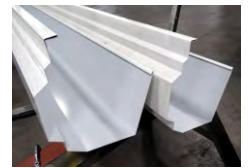
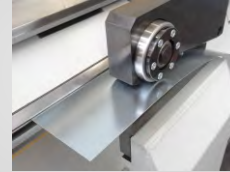
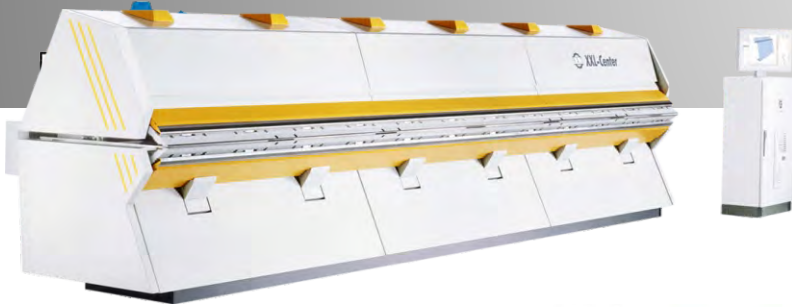

Centros de plegado  
Positivo - Negativo



# JORNS

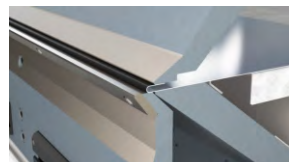

**Schlebach**

*Máquinas perfiladoras para techos,  
fachadas y cubiertas*

*Equipos de perfilado  
Corte y ensamblado*

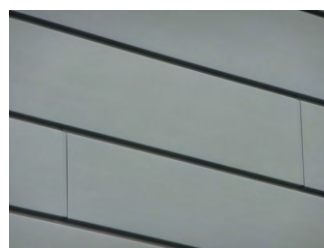

*Dispositivos de corte*

*Longitudinal y transversal*



*Plegadoras portátiles  
ensamblaje de juntas*

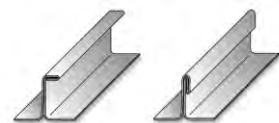

Equipos de plegado  
Portátiles y manuales

Cizallas manuales y  
Eléctricas

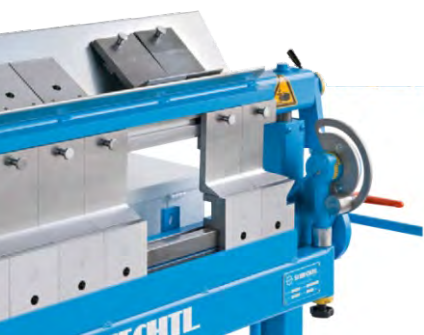
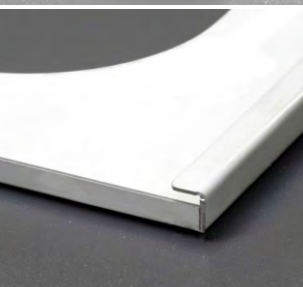

Equipos de plegado  
100% eléctricos





# Máquinas de punzonado, corte y biselado para barra o pletina

Equipos de punzonado y corte descantonado y biselado

Pletinas Plegado, muescado y roscado

## CNC



Equipo de biselado CNC



Equipo de plegado CNC

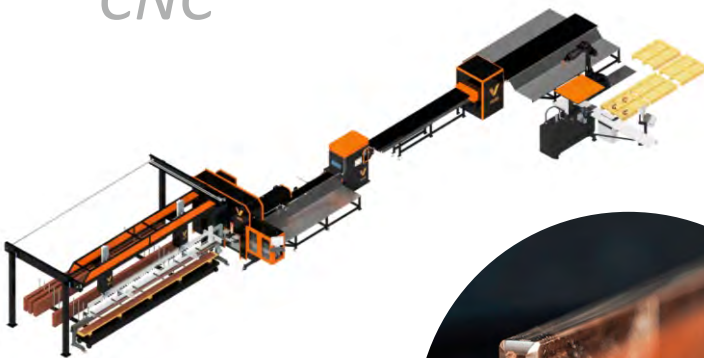

Equipo de punzonado CNC





# Máquinas de corte por láser fibra

Equipos de corte Láser fibra

# 30kW



Aceleración **6G**



PIEZAS POR HORA

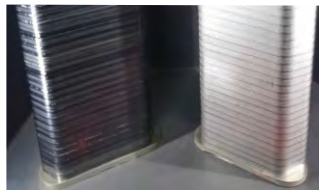

Conectividad Industry 4.0

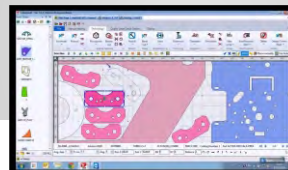

Software Nesting





# Servicios y asistencia técnica

## Servicios Rectificado de herramientas

### Punzonado

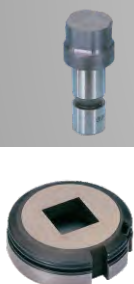

- Un afilado preventivo de los punzones y matrices alarga la vida útil de las herramientas.
- Verificación y control posterior al afilado de las herramientas.
- Servicio de rectificado para todo tipo de útiles de punzonado, incluso para los punzones del tipo A y B de Amada original con alturas de hasta 210 mm.
- Revisión de todos los elementos (chavetas, tornillos, medidas).
- Para un óptimo rectificado utilizamos muelas blandas, gruesas y abiertas de alta calidad.
- Realizamos pasadas suaves y frecuentes con movimiento horizontal para obtener el mejor acabado.



## Servicio técnico Disponible a su Servicio



- Disponemos de un servicio técnico cualificado y comprometido.
- Damos cobertura post-venta de todos los productos representados por Supraform.
- Nuestro equipo de soporte técnico le proporcionará seguridad y estabilidad.
- Asistencia directa a nuestros clientes con indicaciones paso a paso.

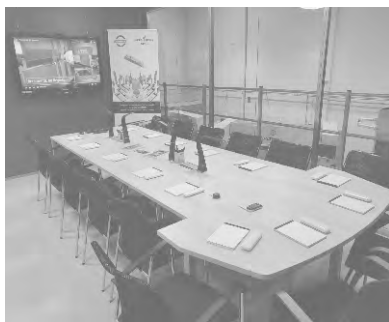

C/ de l'Enginy 14 - P.I. La Post  
08850 Gavà - Barcelona (Spain)  
Tel. +34 93 663 13 00  
Fax +34 93 663 21 61  
E-mail: [supraform@supraform.net](mailto:supraform@supraform.net)  
Web: [www.supraform.net](http://www.supraform.net)

*síguenos en*

