

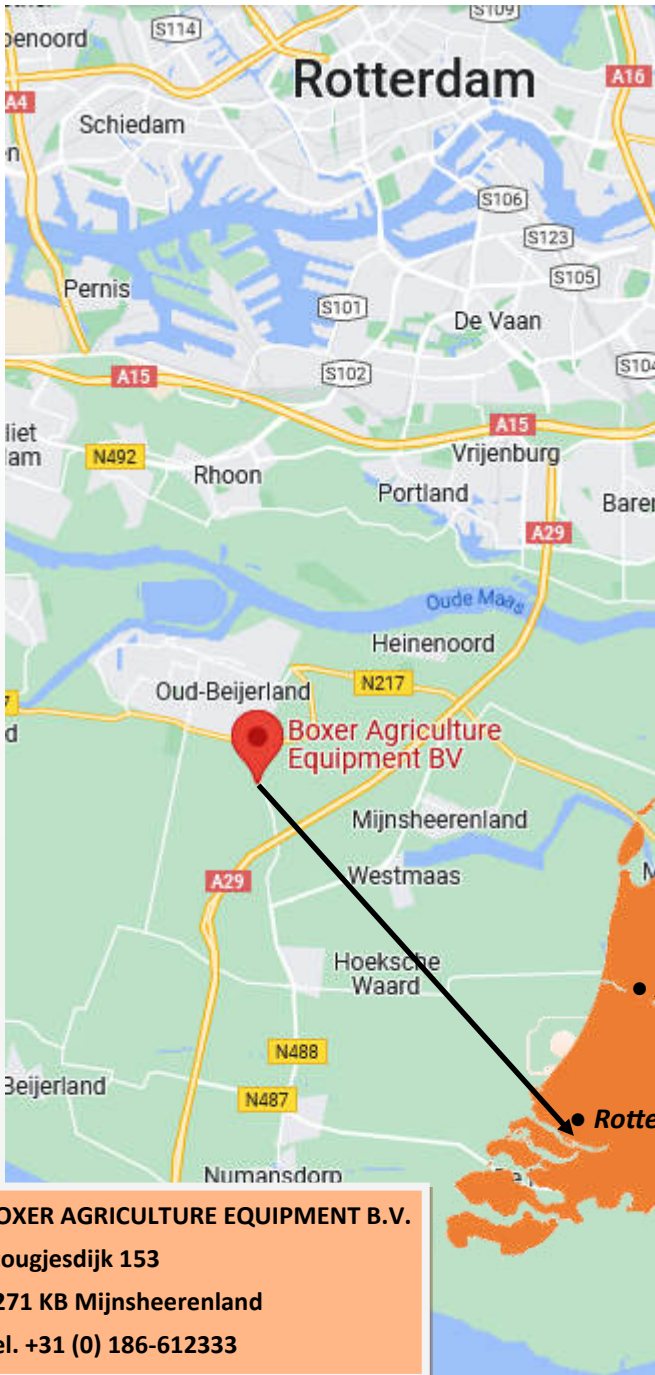

YOUR TRACTOR'S BEST FRIEND

CATALOGUS





BOXER AGRICULTURE EQUIPMENT B.V.

Stougesdijk 153

3271 KB Mijnsheerenland

Tel. +31 (0) 186-612333

Boxer Agriculture Equipment B.V. is gespecialiseerd in de lichtere landbouwwerktuigen en machines. Door directe import kunnen wij deze voor zeer scherpe prijzen leveren.

Prijzen zijn exclusief BTW. Op alle aanbiedingen en overeenkomsten zijn uitsluitend van toepassing onze algemene voorwaarden, gedeponeerd ter griffie van de kamer van koophandel en fabrieken te Rotterdam, onder nummer 23051881 d.d. 21-05-2004. De voorwaarden worden op uw verzoek kosteloos verzonden.

De prijzen en technische gegevens vermeld in deze prijscatalogus zijn vrijblijvend en kunnen zonder voorafgaande kennisgeving worden gewijzigd. De prijzen zijn vermeld in euro's.

Garantieclaims kunnen uitsluitend na voorafgaande toestemming worden gehonoreerd.

Prijzen zijn geldig vanaf 1 april 2022

Boxer Agriculture Equipment B.V. ist spezialisiert auf die leichteren landwirtschaftliche Geräte und Maschinen. Durch den Direktimport können wir diese für sehr wettbewerbsfähigen Preisen anbieten.

Preise sind ohne MwSt. Für alle Angebote und Verträge gelten nur unsere Geschäftsbedingungen, in der Kammer für Handel und Industrie in Rotterdam unter der Nummer 23051881 vom 21-05-2004 eingereicht. Die Bedingungen wird Ihnen auf Anfrage kostenlos geschickt.

Preise und Spezifikationen, aufgeführt in diesem Katalog, sind unverbindlich und können sich ohne vorherige Ankündigung ändern. Die Preise sind in Euro.

Nur nach vorheriger Genehmigung können Gewährleistungsansprüche erfüllt werden.

Preise gelten ab 1. April 2022

Boxer Agriculture Equipment B.V. se spécialise dans les outils et machines agricoles légères. Grâce à l'importation directe nous pouvons offrir ce à des prix très compétitifs.

Les prix excluent la TVA. Toutes les offres et les accords ne sont que des termes et conditions applicables, déposées à la Chambre de Commerce et d'Industrie à Rotterdam sous le numéro 23051881 en date du 21-05-2004. Les conditions seront envoyés gratuitement sur demande.

Prix et spécifications techniques figurant dans ce catalogue sont prix non contraignantes et sont sujets à changement sans préavis. Les prix sont en euros .

Les réclamations de garantie peut être invoqué uniquement après autorisation préalable.

Les prix sont valables de Avril 1, 2022

Boxer Agriculture Equipment B.V. specializes in the lighter agricultural implements and machines. Because of the direct import we can provide this for very competitive prices.

Prices exclude VAT. All offers and agreements are only applicable with our terms and conditions, filed at the Chamber of Commerce and Industry in Rotterdam under number 23051881 dated 21-05-2004. The conditions will be sent free of charge upon request.

Prices and specifications listed in this catalog are non-binding and are subject to change without notice. The prices are in euros.

Warranty claims can be honored only after our prior permission.

Prices are valid from April 1, 2022

GRASLANDBEWERKING

CIRKELMAAIER	FA - FAG - FA XL - LM - FMU - FMU D	8 - 13
WEIDEBLOTTER	BL - BLG - WB - WB XL/XXL	14 - 17
KLEPELMAAIER	EF - G2 - MASTER - WLF - KDK - DUO - DUO PLUS	18 - 25
VERSTEEKLEPELMAAIER	AGL MINI - AGL - AGF - AGF PRO - BLACK - AGX	26 - 36
ARMMAAIER	AM - AM 110 - AM 130	37 - 39
HEGGENSCHAAR COMPLEET	HSC - HSC XL - FHCS	40 - 42
HEGGENSCHAAR	HS	43
ZAAGKOP	CUT	44
KLEPELBAK	EXF	45
HYDR. DISCMAAIER	HDM - HDMA	46 - 47
KLEPELMAAIER MET OPVANGBAK	LOW - HIGH - IA	48 - 50
CYCLOMAAIER	CM	51
RONDE BALENPERS	RBP	52
BALENWIKKELAAR	MW	53
ATV MAAIER	ATV	54
COMBIHARK	HB	55

GRONDBEWERKING

ROTOR-EG	PI - PX	58 - 59
ZAAICOMBINATIE	ZM - SB Z	60 - 61
OVERTOPFREES	SB - SB HD	62 - 63
GRONDFREES	GF - GF T - GF TA - GF TCA - GF XL	64 - 68
SLEUVENFREES	D0	69
GREPELFREES	GREP - FG	70 - 71
AARDAPPELPOOTMACHINE	AP	72
AARDAPPELROOIER	PD	73
PLOEG	FZL	74
SPITMACHINE	DM	75
GRONDBOOR	GB3P	76

VLAKKER - WEIDESLEEP

WEIDESLEEP	WS	78
LANDLEVELLER	LL	79
BODEMVLAKKER	EE - EE ATV - PISTE PROFI	80 - 82

TERREIN- EN WEGENBEHEER

ZOUTSTROOIER	ZS - TS	84 - 85
SNEEUWSCHUIF	SS - PU - PUV - SSV	86 - 89
VEEGMACHINE	VM - VM XL	90 - 91
ONKRUIDBORSTEL	OB	92

AANBOUWDELEN / DIVERSEN

PUINBAK	W PB	94
TEGELRIEK	TR	95
4 - 1 BAK	4 - 1 FT	96
MESTVORK	MG	97
HYDRAULISCHE KLEM	BK - BKV	98 - 99
PELIKAANBAK	PB	100
HOUTKLEM	HK	101

BOSBOUW

HOUTVERSNIPPERAAR	HV - WCL - MHV	103 - 108
HOUTKLOVER	LS	109
BOMENFREES	BM - BM HD - EFM	110 - 112

KIPWAGENS

KIPWAGEN	HT	114 - 115
----------	----	-----------

GRAAFMACHINE

BACKHOE / ACHTERLADER	AL MINI - AL	117
GRAAFMACHINE	ME - HSW G	118 - 121

LEGENDA

SYMBOLLEN	122 - 123
-----------	-----------







GRASLANDBEWERKING
GRÜNLANDGERÄTE
BROYAGE ENTRETIEN
GRASSLAND EQUIPMENT









CIRKELMAAIER

Kreiselmulcher • Tondeuse à gazon • Rotary mower



G
R
A
S
L
A
N
D
B
E
W
E
R
K
I
N
G

FA

				 HP				
FA 1200	120	540	12 - 40	CAT. I	130	3	1.125,-	
FA 1500	150	540	18 - 50	CAT. I	153	3	1.255,-	
FA 1800	180	540	22 - 50	CAT. I	205	3	1.650,-	
FA 2100	210	540	30 - 65	CAT. I	265	3	2.110,-	

Losse slijtonderdelen:



Messen

Artikelcode: FA001 - p.st. € 18,-
 FA002 - p.st. € 19,50
 FA003 - p.st. € 25,50











CIRKELMAAIER

Kreiselmulcher • Tondeuse à gazon • Rotary mower



FAG

								
FAG 1200	120	540	14 - 40	CAT. I	195	3	1.325,-	
FAG 1500	150	540	14 - 40	CAT. I	220	3	1.525,-	
FAG 1800	180	540	14 - 50	CAT. I	250	3	1.725,-	

Losse slijtonderdelen:



Messen

Artikelcode: FA001 - p.st. € 18,-

FA002 - p.st. € 19,50









FA003 - p.st. € 25,50

CIRKELMAAIER

Kreiselmulcher • Tondeuse à gazon • Rotary mower



FA XL

								
FA 1500 XL	150	540	18 - 50	CAT. I	200	3	2.100,-	
FA 1800 XL	180	540	22 - 50	CAT. I	235	3	2.425,-	
FA 2100 XL	210	540	22 - 60	CAT. I	330	3	2.890,-	

Losse slijtonderdelen:



Messen

Artikelcode: FAX004 - p.st. € 18,-
FAX005 - p.st. € 19,50
FAX007 - p.st. € 25,50



HYDRAULISCHE CIRKELMAAIER









Hydraulic mulcher • Hydraulic tondeuse à gazon • Hydraulic rotary mower



Eurotrac W/ALH20
snelwissel

* Cirkelmaaier voor wiellader

LM

			 Ltr	 HP		 kg		
LM 1200	120	29 - 32	14 - 40	W.	235	3	2.200,-	
LM 1500	150	29 - 32	14 - 40	W.	250	3	2.275,-	
LM 1800	180	45	14 - 50	W.	275	3	2.450,-	

Losse slijtonderdelen:



Messen

Artikelcode: LM1201 - p.st. € 18,-
LM1501 - p.st. € 19,50
LM1801 - p.st. € 25,50

Meerprijs:









Euro- ipv W-aansluiting: € 175,-

CIRKELMAAIER

Kreiselmulcher • Tondeuse à gazon • Rotary mower



FMU

								
FMU 150	150	540	18 - 50	CAT. I	200	6	2.550,-	
FMU 180	180	540	22 - 50	CAT. I	235	6	2.770,-	



Losse slijtonderdelen:

Messen p.st. € 12,50

Artikelcode: FMU220117

G
R
A
S
L
A
N
D
B
E
W
E
R
K
I
N
G









CIRKELMAAIER

Kreiselmulcher • Tondeuse à gazon • Rotary mower



* Maaier met denker

FMU-D

				 HP				
FMU 150D	150	540	18 - 50	CAT. I	200	8	2.920,-	
FMU 180D	180	540	22 - 50	CAT. I	235	8	3.070,-	

Losse slijtonderdelen:

Messen p.st. € 12,50

Artikelcode: FMU220117

WEIDEBLOTER

Rasenmulcher • Gyrobroyeur • Duty slasher



* Direct aangedreven

BL

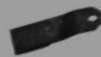

BL 120

120

540

14 - 40

CAT. I

186

2

1.610,-

Losse slijtonderdelen:

Messen p.st. € 28,50

Artikelcode: BL001

G
R
A
S
L
A
N
D
B
E
W
E
R
K
I
N
G









WEIDEBLOTER

Rasenmulcher • Gyrobroyeur • Duty slasher



* Direct aangedreven

BLG

								
BLG 120	120	540	14 - 40	CAT. I	210	2	1.600,-	
BLG 160	160	540	25 - 60	CAT. I	316	2	2.025,-	
BLG 200	200	540	40 - 80	CAT. II	458	2	2.790,-	

Losse slijtonderdelen:



Messen p.st. € 17,50
 Artikelcode: BLGD001











WEIDEBLOTER

Rasenmulcher • Gyrobroyeur • Duty slasher



* V-snaar aandrijving

WB

				 HP				
WB 185	185	540	30 - 70	CAT. II	240	4	2.435,-	
WB 275	275	540	50 - 80	CAT. II	485	6	2.975,-	

Losse slijtonderdelen:



Messen p.st. € 17,50

Artikelcode: WB001

G
R
A
S
L
A
N
D
B
E
W
E
R
K
I
N
G

WEIDEBLOTER

Rasenmulcher • Gyrobroyeur • Duty slasher









WB240 XL



WB300 XXL

* Direct aangedreven

WB XL / XXL

							
WB 240XL	240	540	60 - 90	CAT. II	4	3.580,-	
WB 300XXL	300	540	70 - 120	CAT. II	4	4.350,-	

Losse slijtonderdelen:



Messen

Artikelcode: WB240XL001 - p.st. € 22,50









Artikelcode: WB300XL001 - p.st. € 27,50

KLEPELMAAIER

Schlegelmulcher • Broyeur fixe • Flail mower



EF

							
EF 95	95	540	12 - 25	CAT. I	115	30	1.360,-
EF 115	115	540	20 - 30	CAT. I	145	42	1.400,-
EF 135	135	540	20 - 30	CAT. I	175	48	1.625,-
EF 175	175	540	20 - 30	CAT. I	225	60	1.750,-

Losse slijtonderdelen:



Y - klepels p.st. € 4,50

Artikelcode: EF001

KLEPELMAAIER

Schlegelmulcher • Broyeur légère • Flail mower

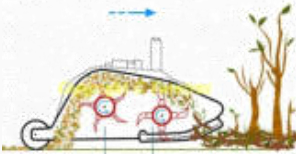

G2

G2 150	150	540	65 - 80	CAT. I/II	510	72	23	3.595,-	
G2 180	180	540	80 - 110	CAT. I/II	580	86	28	3.965,-	

Losse slijtonderdelen: Y - klepels p.st. € 5,50

Artikelcode: G2H150111 (breed)
G2H150111S (smal)



Verticuteer mes p.st. € 5,45

Artikelcode: G2H150111B (breed)
G2H150111BS (smal)



Hamerklepels p.st. € 7,25

Artikelcode: G2H150111A











KLEPELMAAIER

Schlegelmulcher • Broyeur fixe • Flail mower



MASTER

							
MASTER 125 M	125	540	18 - 25	CAT. I	277	20	1.780,-
MASTER 145 M	145	540	25 - 35	CAT. I	317	24	1.850,-
MASTER 155 M	155	540	30 - 65	CAT. I	342	24	2.025,-
MASTER 175 M	175	540	35 - 65	CAT. I	392	28	2.165,-

Losse slijtonderdelen:



Hamerklepels p.st. € 7,25

Artikelcode: MAH003

G
R
A
S
L
A
N
D
B
E
W
E
R
K
I
N
G









KLEPELMAAIER

Schlegelmulcher • Broyeur à déplacement • Flail mower



* Hydraulische side shift

MASTER

								
MASTER 155	155	540	30 - 65	CAT. I	367	24	2.165,-	
MASTER 175	175	540	35 - 65	CAT. I	412	28	2.225,-	
MASTER 200	200	540	55 - 70	CAT. I/II	460	32	2.636,-	
MASTER 220	220	540	75 - 90	CAT. I/II	500	36	2.925,-	

Losse slijtonderdelen:



Hamerklepels p.st. € 7,25

Artikelcode: MAH003

HYDRAULISCHE KLEPELMAAIER

Hydraulischer Schlegelmulcher • Hydraulic Broyeur fixe • Hydraulic Flail mower



* Klepelmaaier voor wiellader

Eurotrac W/ALH20
snelwissel

WLF

WLF 1300	130	33 - 50	40 - 45	W.	320	22	3.120,-	
WLF 1700	170	33 - 50	40 - 45	W.	353	28	3.270,-	

Losse slijtonderdelen:



Hamerklepels p.st. € 6,50
Artikelcode: WLF001

Meerprijs:

Euro- ipv W aansluiting: € 175,-









G
R
A
S
L
A
N
D
B
E
W
E
R
K
I
N
G

KLEPELMAAIER

Schlegelmulcher • Broyeur à déplacement • Flail mower



KDK

								
KDK 240	240	540	75 - 120	CAT. II	650	22	4.450,-	
KDK 300	300	540	100 - 150	CAT. II	1200	30	7.525,-	

Losse slijtonderdelen:



Wielset € 250,-
Artikelcode: KDK001











Hamerklepels p.st. € 9,10
Artikelcode: AGF001

KLEPELMAAIER

Schlegelmulcher • Broyeur réversible • Flail mower



DUO

								
DUO 140	138	540	20 - 50	CAT. I/II	320	12	2.975,-	
DUO 170	168	540	30 - 50	CAT. I/II	370	16	3.085,-	
DUO 200	196	540	40 - 70	CAT. II	410	18	3.940,-	
DUO 220	218	540	55 - 80	CAT. II	460	20	4.245,-	

Losse slijtonderdelen:



Hamerklepels p.st. € 9,10









Artikelcode: AGF001

KLEPELMAAIER

Schlegelmulcher • Broyeur à déplacement • Flail mower



DUO plus

							
DUO 250 plus	250	1000	85 - 150	CAT. II/III	960	22	6.200,-
DUO 280 plus	280	1000	100 - 150	CAT. II/III	1064	26	6.625,-
DUO 300 plus	300	1000	100 - 150	CAT. II/III	1230	30	6.815,-

Losse slijtonderdelen:

Hamerklepels p.st. € 15,55

Artikelcode: DUO001P











VERSTEKKLEPELMAAIER

Mulcher • Broyeur • Flail mower



AGL MINI

								
AGL 110 MINI		110	540	15 - 35	CAT. I	230	18	2.450,-
AGL 130 MINI		130	540	18 - 50	CAT. I	260	22	2.540,-

Losse slijtonderdelen:



Hamerklepels p.st. € 6,50

Artikelcode: AGLM001

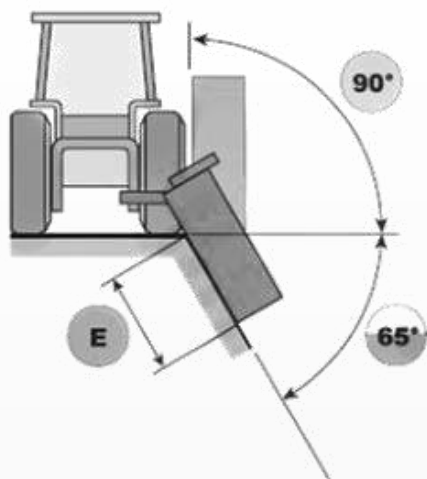
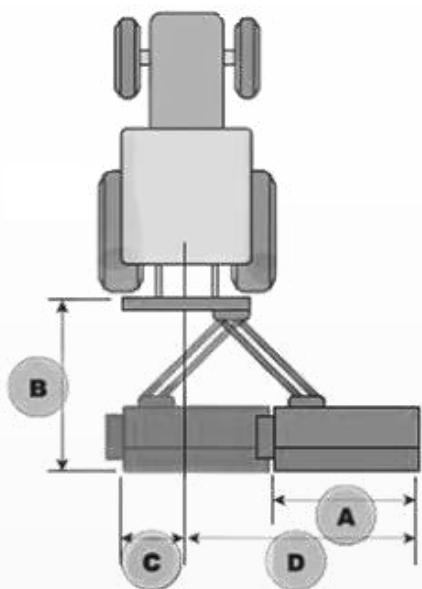

TABEL

(M)	A	B	C	D	E
AGL 110 MINI	110	120	40	183	85
AGL 130 MINI	130	120	40	203	105

VERSTEKKLEPELMAAIER

Mulcher • Broyeur • Flail mower











Losse slijtonderdelen:



Hamerklepels p.st. € 6,50

Artikelcode: AGL001

AGL

								
AGL 125	125	540	20 - 60	CAT. I	250	20	2.570,-	
AGL 145	145	540	25 - 60	CAT. I	270	24	2.760,-	
AGL 165	165	540	30 - 70	CAT. I	290	28	3.005,-	
AGL 185	185	540	40 - 75	CAT. I/II	342	30	3.230,-	
AGL 200	200	540	45 - 80	CAT. I/II	355	32	3.455,-	

G
R
A
S
L
A
N
D
B
E
W
E
R
K
I
N
G

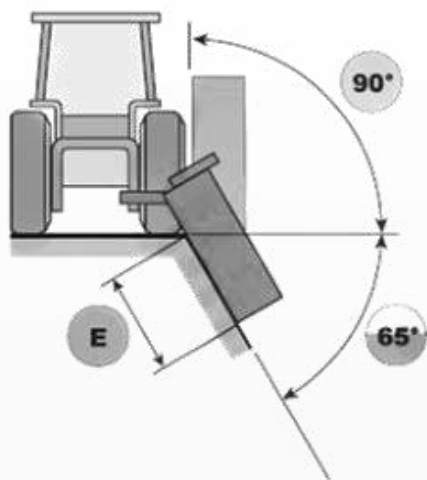
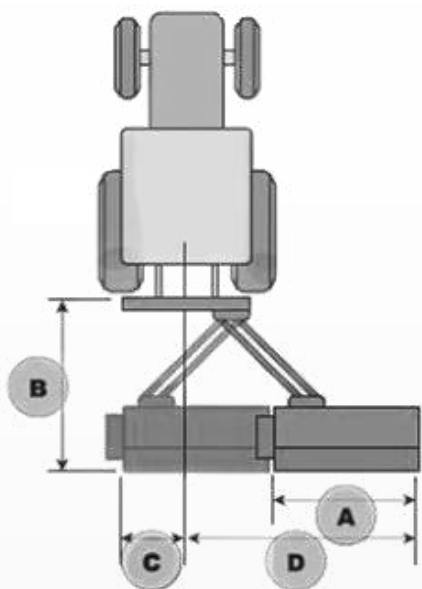

TABEL

(M)	A	B	C	D	E
AGL 125	120	130	76	180	105
AGL 145	140	130	76	200	125
AGL 165	160	130	76	220	145
AGL 185	185	130	66	235	165
AGL 200	200	130	66	250	180

VERSTEEKLEPELMAAIER

Mulcher • Broyeur • Flail mower



Losse slijtonderdelen:



Hamerklepels p.st. € 9,10

Artikelcode: AGF001

AGF

								
AGF 140	140	540	50 - 80	CAT. II	520	14	3.850,-	
AGF 160	160	540	60 - 95	CAT. II	560	16	4.025,-	
AGF 180	180	540	70 - 110	CAT. II	600	18	4.200,-	
AGF 200	200	540	80 - 110	CAT. II	650	20	4.525,-	
AGF 220	220	540	90 - 120	CAT. II	685	20	4.650,-	
AGF 240	240	540	90 - 130	CAT. II	720	24	4.795,-	

G
R
A
S
L
A
N
D
B
E
W
E
R
K
I
N
G

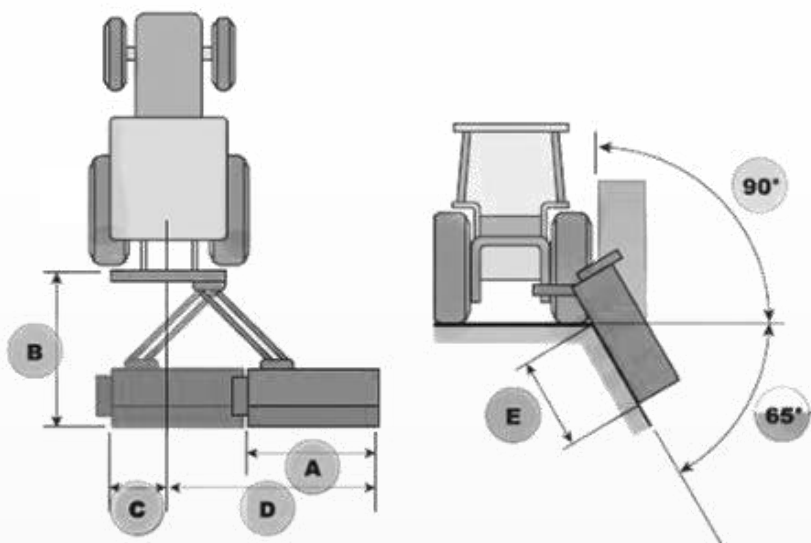

TABEL









(M)	A	B	C	D	E
AGF 140	140	163	24	234	120
AGF 160	160	163	24	254	140
AGF 180	180	163	24	274	160
AGF 200	200	165	24	292	180
AGF 220	220	165	24	312	200
AGF 240	240	165	24	312	220

VERSTEKKLEPELMAAIER

Mulcher • Broyeur • Flail mower



AGF PRO

							
AGF 180 PRO	180	540	70 - 110	CAT. II	660	18	4.485,-
AGF 200 PRO	200	540	80 - 110	CAT. II	710	20	4.810,-
AGF 220 PRO	220	540	90 - 120	CAT. II	750	20	4.935,-
AGF 240 PRO	240	540	90 - 130	CAT. II	790	24	5.070,-

Losse slijtonderdelen:



Hamerklepels p.st. € 9,10

Artikelcode: AGF001

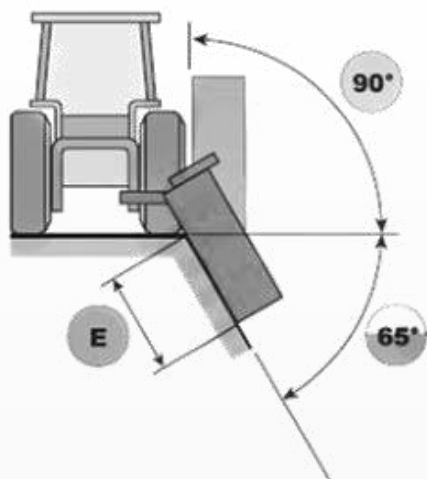
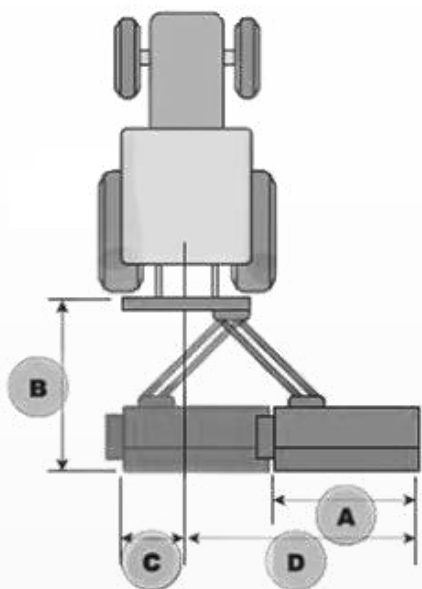

TABEL







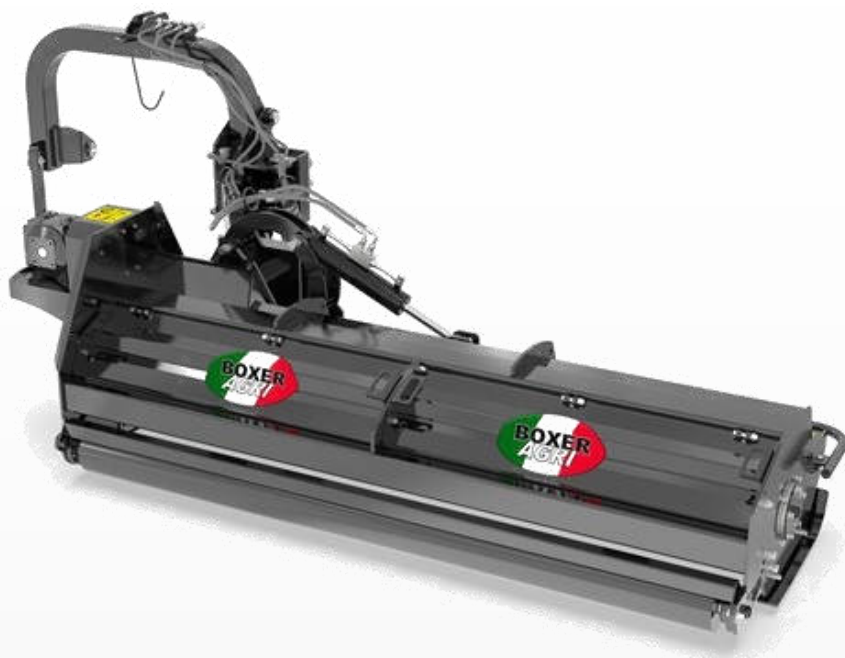

(M)	A	B	C	D	E
AGF 180 PRO	180	163	24	274	160
AGF 200 PRO	200	165	24	292	180
AGF 220 PRO	220	165	24	312	200
AGF 240 PRO	240	165	24	312	220

VERSTEKKLEPELMAAIER

Mulcher • Broyeur • Flail mower



BLACK

								
BLACK 180	180	540	70-110	CAT. II	705	16	5.390,-	
BLACK 200	200	540	80-110	CAT. II	735	18	5.435,-	
BLACK 220	220	540	100-160	CAT. II	804	20	5.520,-	
BLACK 250	250	540	100-160	CAT. II	860	20	6.445,-	

Losse slijtonderdelen:



Hamerklepels p.st. € 9,10

Artikelcode: AGF001

G
R
A
S
L
A
N
D
B
E
W
E
R
K
I
N
G

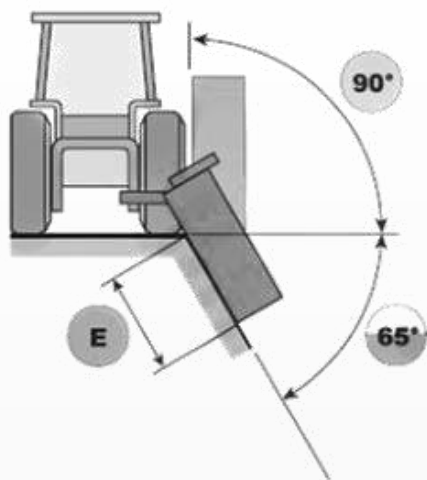
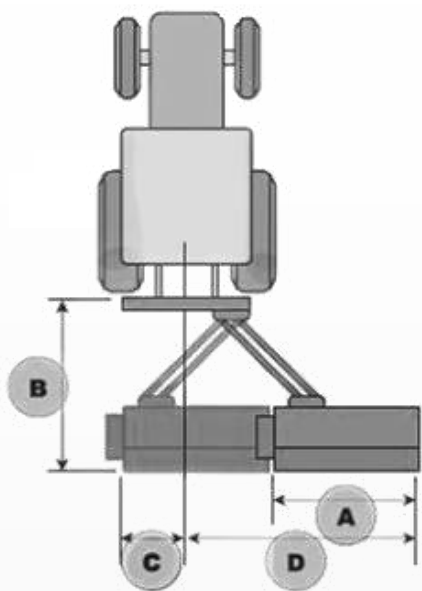

TABEL

(M)	A	B	C	D	E
BLACK 180	180	165	24	250	160
BLACK 200	200	165	24	270	180
BLACK 220	220	165	24	290	200
BLACK 250	250	165	24	320	230

VERSTEKKLEPELMAAIER

Schlegelmulcher • Broyeur d'accotement • Flail mower



AGX



AGX 200

200

540

85 - 115

CAT. II

1070

60

7.900,-

Losse slijtonderdelen:



Klepels p.st. € 8,50

Artikelcode: AGX001

G
R
A
S
L
A
N
D
B
E
W
E
R
K
I
N
G

ARMMAAIER

Schlegelmulcher • Débronsailleuse • Flail mower

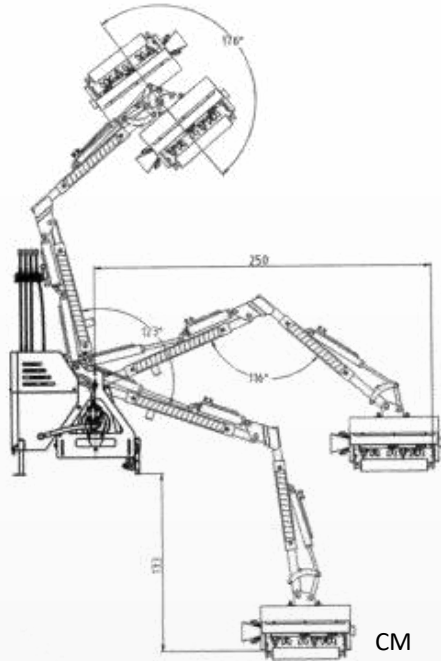

AM

AM 60	60	540	18 - 50	CAT. I	260	55	24	5.720,-	
AM 80	80	540	25 - 60	CAT. I	275	55	32	6.120,-	

Losse slijtonderdelen:



Y - klepels p.st. € 4,75
 Artikelcode: AMH6002106

ARMMAAIER

Schlegelmulcher • Débrossailleuse • Flail mower

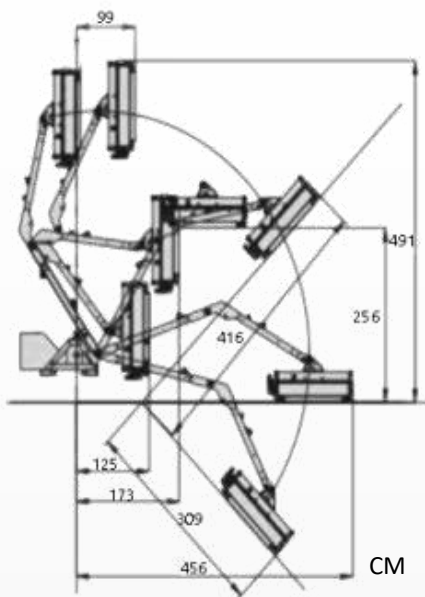

AM 110

AM 110-37	110	375	540	40 - 70	CAT. II	1700	610	7.920,-	
AM 110-42	110	422	540	40 - 70	CAT. II	2000	640	8.125,-	
AM 110-46	110	470	540	50 - 80	CAT. II	2200	700	8.790,-	
AM 110-56	110	550	540	60 - 90	CAT. II	2500	751	9.390,-	

Losse slijtonderdelen:



Y - klepels p.st. € 5,25

Artikelcode: FHHM46010006

Verticuteer mes p.st. € 6,75

Artikelcode: FHHM46010005

G
R
A
S
L
A
N
D
B
E
W
E
R
K
I
N
G

ARMMAAIER

Schlegelmulcher • Débrossailleuse • Flail mower

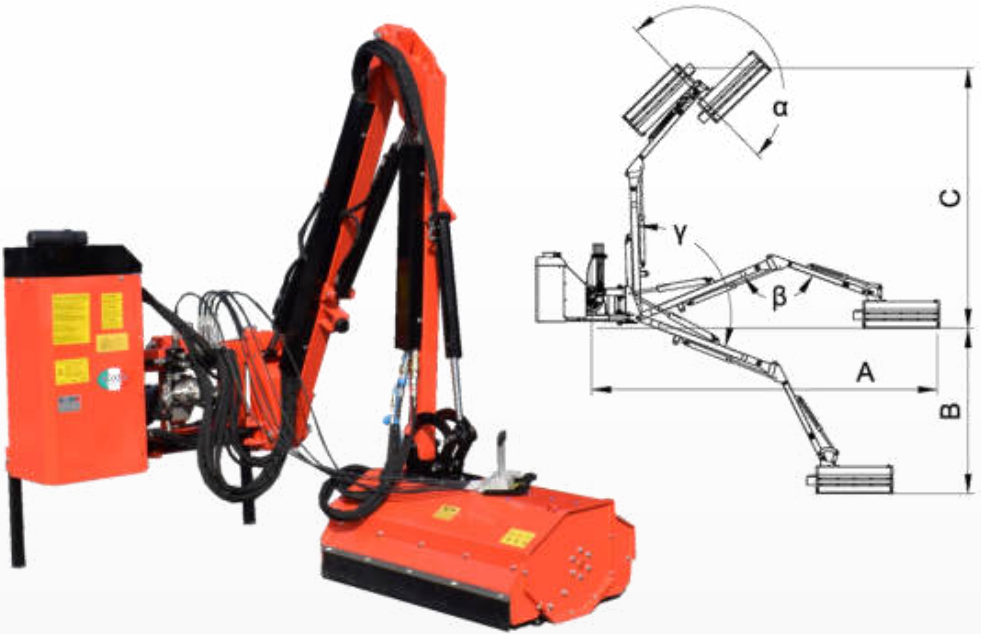

AM 130

AM 130-62	130	540	90 - 120	CAT. II	3500	1050	180	52	11.200,-

	α	β	γ	A	B	C
AM 130-62	180°	137°	113°	620 cm	300 cm	470 cm

HEGGENSCHAAR COMPLEET

Heckenschere Komplett • Taille-haies complet • Hedge trimmer complete

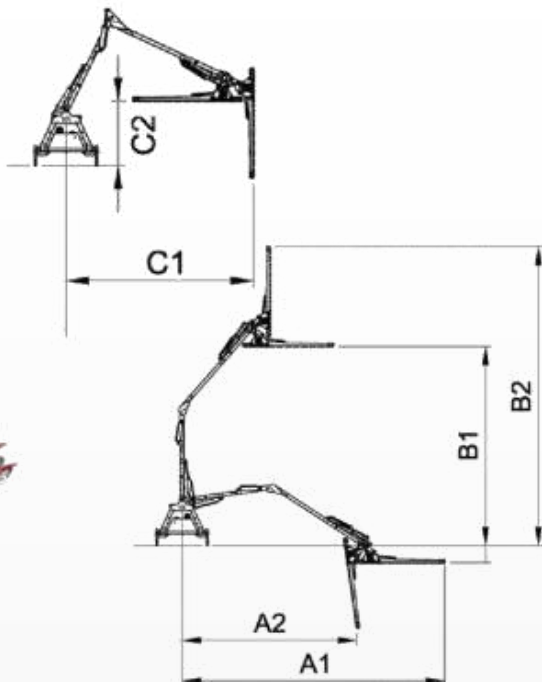

HSC



HSC 130

130

540

20 - 40

CAT. I

293

20

4.255,-

HSC 160

160

540

25 - 40

CAT. I

300

20

4.335,-

A1

A2

B1

B2

C1

C2

HSC 130

400 cm

270 cm

320 cm

470 cm

230 cm

100 cm

HSC 160

480 cm

320 cm

370 cm

550 cm

280 cm

100 cm

Losse slijtonderdelen:

Messenbalk

Type: 130 - Artikelcode: AMC1300011 € 55,-

Type: 160 - Artikelcode: AMC1600011 € 65,-

Type: 175 - Artikelcode: AMC1750011 € 75,-

Type: 190 - Artikelcode: AMC190011 € 85,-

G
R
A
S
L
A
N
D
B
E
W
E
R
K
I
N
G

40

HEGGENSCHAAR

Heckenschere • Taille-haies • Hedge trimmer

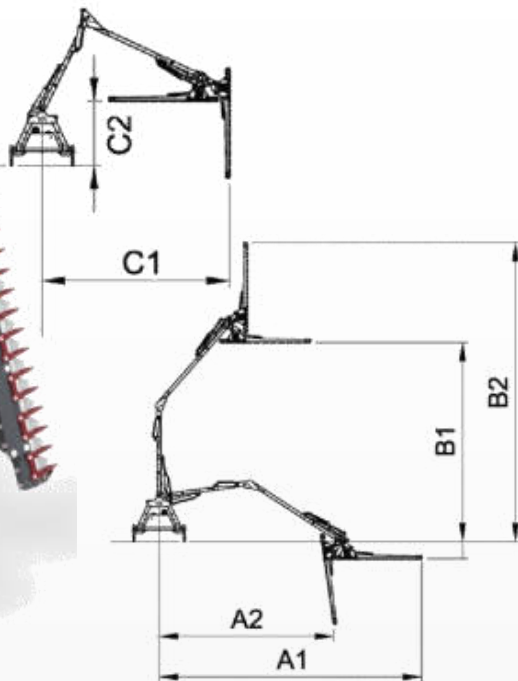

HSC-XL



HSC 160XL

160

540

25 - 40

CAT. I

330

20

5.275,-

A1

A2

B1

B2

C1

C2

HSC 160XL

480 cm

320 cm

370 cm

550 cm

280 cm

100 cm

Losse slijtonderdelen:

Messenbalk

Type: 130 - Artikelcode: AMC1300011 € 55,-

Type: 160 - Artikelcode: AMC1600011 € 65,-

Type: 175 - Artikelcode: AMC1750011 € 75,-

Type: 190 - Artikelcode: AMC190011 € 85,-

Mesbescherming

Artikelcode: AMC1300101 € 24,50

FRONT HEGGENSCHAAR

Front Heckenschere • Taille-haies Frontal • Front Hedge trimmer



*Verkrijgbaar in Euro- en W- aansluiting

MAX. 2 - 4 KM/H

FHCS

FHSC 160 E	160	3	80	300	140 - 180	20	2.950,-
FHSC 160 W	160	3	80	300	140 - 180	20	2.950,-

Losse slijtonderdelen:

Messenbalk

Type: 130 - Artikelcode: AMC1300011	€ 55,-
Type: 160 - Artikelcode: AMC1600011	€ 65,-
Type: 175 - Artikelcode: AMC1750011	€ 75,-
Type: 190 - Artikelcode: AMC190011	€ 85,-

Mesbescherming

Artikelcode: AMC1300101 € 24,50





G
R
A
S
L
A
N
D
B
E
W
E
R
K
I
N
G

HEGGENSCHAAR

Heckenschere • Taille-haies • Hedge trimmer



HS

				
HS 130	130	36	25	1.050,-
HS 160	160	43	25	1.100,-
HS 175	175	46	25	1.150,-
HS 190	190	51	25	1.350,-

Losse slijtonderdelen:

Messenbalk

Type: 130 - Artikelcode: AMC1300011 € 55,-

Type: 160 - Artikelcode: AMC1600011 € 65,-

Type: 175 - Artikelcode: AMC1750011 € 75,-

Type: 190 - Artikelcode: AMC190011 € 85,-

Mesbescherming





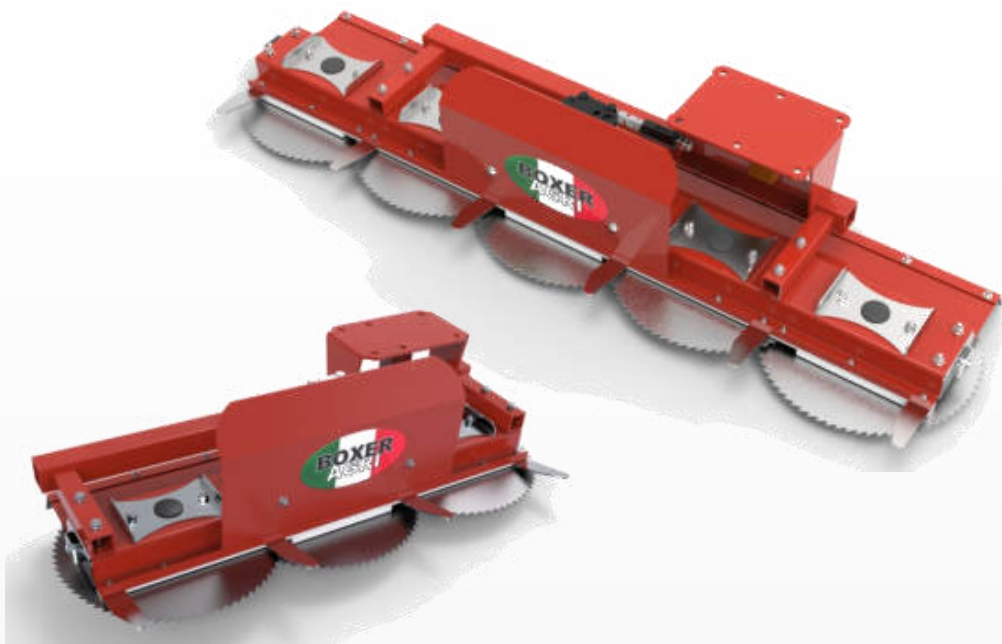

Artikelcode: AMC1300101 € 24,50

CUT ZAAGKOP

Sägekopf • Tête de scie • Saw head



CUT

					
CUT 3	90	53	40	3	1.875,-
CUT 5	150	77	70	5	2.480,-

G
R
A
S
L
A
N
D
B
E
W
E
R
K
I
N
G









KLEPELBAK

Mulchköpfe • Bras de débroussailluse • Flail heads



* Klepelbak voor graafmachine

EXF

			 Ltr	 t.				
EXF 600	60	30 - 40	1.5 - 2.5	200	240	12	2.885,-	
EXF 800	80	40 - 60	3 - 5	200	272	14	3.050,-	
EXF 1200	120	60 - 80	6 - 8	200	305	18	3.750,-	

Losse slijtonderdelen:

Hamerklepel

Type: 600	- Artikelcode: EXFJ002	€ 7,25
Type: 800	- Artikelcode: EXFJ001	€ 9,25
Type: 1200	- Artikelcode: EXFJ001	€ 9,25

HYDRAULISCHE DISKMAAIER

Hydr. Scheibenmäher • Hydr. Faucheuses à disques • Hydr. disc mower



HDM



HDM 60



60



18 - 35



CAT. I



246

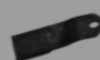

2



2.950,-

HYDRAULISCHE DISKMAAIER

Hydr. Scheibenmäher • Hydr. Faucheuses à disques • Hydr. disc mower



HDMA

(M)

HDMA 56

Ø

56

€









1.275,-

KLEPELMAAIER

Schlegelmulcher • Broyeur à collecteur • Flail mower



LOW

									
LOW 120	115	550	540	20 - 40	CAT. I	330	28	2.665,-	
LOW 160	155	700	540	28 - 50	CAT. I	370	36	3.275,-	

Losse slijtonderdelen:



Hamerklepels p.st. € 5,25

Artikelcode: ATV002

G
R
A
S
L
A
N
D
B
E
W
E
R
K
I
N
G

KLEPELMAAIER

Schlegelmulcher • Broyeur à collecteur • Flail mower



HIGH

HIGH 125	121	145	500	540	25 - 40	CAT. I/II	410	20	3.440,-	
HIGH 165	161	145	650	540	40 - 65	CAT. I/II	490	28	3.705,-	
HIGH 200	195	145	800	540	70 - 100	CAT. I/II	580	32	4.265,-	

Losse slijtonderdelen:



Hamerklepels p.st. € 6,25
 Artikelcode: FCHH001



EASY CUT COLLECTOR

Mulcher Grasshopper • Grasshopper • Grasshopper



IA - EASY CUT



IA 1800



180



3000



45 - <



CAT. II/III



1290



12.145,-

G
R
A
S
L
A
N
D
B
E
W
E
R
K
I
N
G

CYCLOMAAIER

Trommelmäher • Faucheuses à disques • rotary disc mower



CM 100
CM 140



CM 165
CM 185

CM

(M)				(C)			(€)
CM 100	100	540	10 - 30	CAT. I	140	6	1.600,-
CM 140	140	540	25 - 35	CAT. I	210	6	1.725,-
CM 165	165	540	30 - 60	CAT. II	340	6	2.260,-
CM 165 H*	165	540	55 - 90	CAT. II	340	6	2.635,-
CM 185	185	540	30 - 60	CAT. II	410	6	2.635,-
CM 185 H*	185	540	55 - 90	CAT. II	410	6	2.995,-

*H - Hydraulisch opklapbaar

BALENPERS

Ballenpresse • Press à balles rondes • Round baler



RBP



RBP 7060

80

540

25 - 50

CAT. I

440

60 X 70

5.765,-

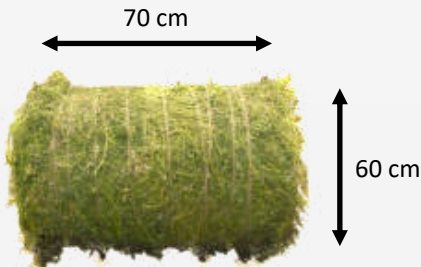

Extra:

Bindtouw per rol € 25,50

Artikelcode: RBP002

G
R
A
S
L
A
N
D
B
E
W
E
R
K
I
N
G

BALENWIKKELAAR

Ballenwickler • Enrubanneuses • Bale wrapper



MW



MW 6070



40 sec.
Per baal



1,4
benzine



85



60 x 70



2.650,-



ATV MAAIER

ATV Mulcher • ATV Tondeuse à gazon • ATV Flail mower



ATV



ATV 120



120



3 - 20



15



230



28



2.300,-

Losse slijtonderdelen:



Hamerklepels p.st. € 5,25

Artikelcode: ATV002

G
R
A
S
L
A
N
D
B
E
W
E
R
K
I
N
G

COMBI HARK

Heumaschine • Andaineurs-faneurs • Tedder-Rake Combination



HB

HB 275	300	540	30 - 70	CAT. II	300	4.150,-





GRONDBEWERKING
BODENBEARBEITUNG
TRAVAIL DU SOL
CULTIVATION

ROTOREG

Kreiselegge • Herse rotatives • Rottery harrow

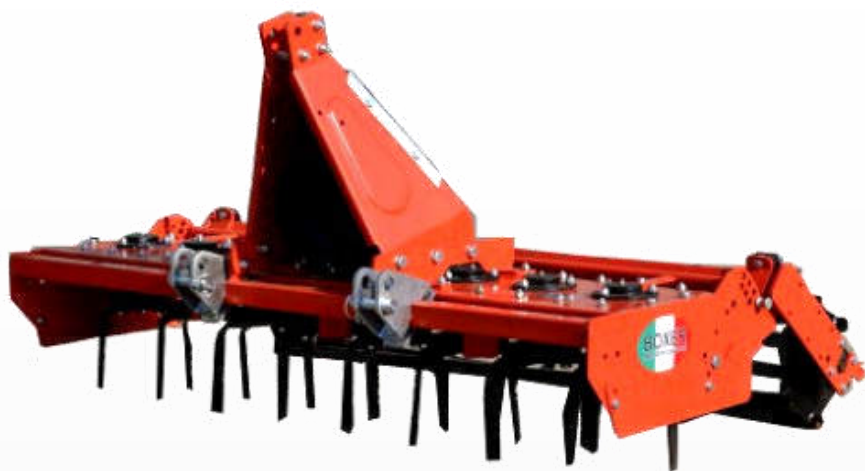

Losse slijtonderdelen:











Tand p.st. € 9,50

Artikelcode: PILXG170109A (Links)

PILXG170109 (Rechts)

PI

								
PI 90	90	540	16 - 25	CAT. I	230	8	2.250,-	
PI 110	110	540	20 - 30	CAT. I	250	10	2.260,-	
PI 135	135	540	20 - 35	CAT. I	260	12	2.460,-	
PI 175	175	540	30 - 60	CAT. I	320	16	2.760,-	
PI 200	200	540	40 - 70	CAT. I	380	20	3.035,-	

ROTOREG

Kreiselegge • Herse rotatives • Rottery harrow

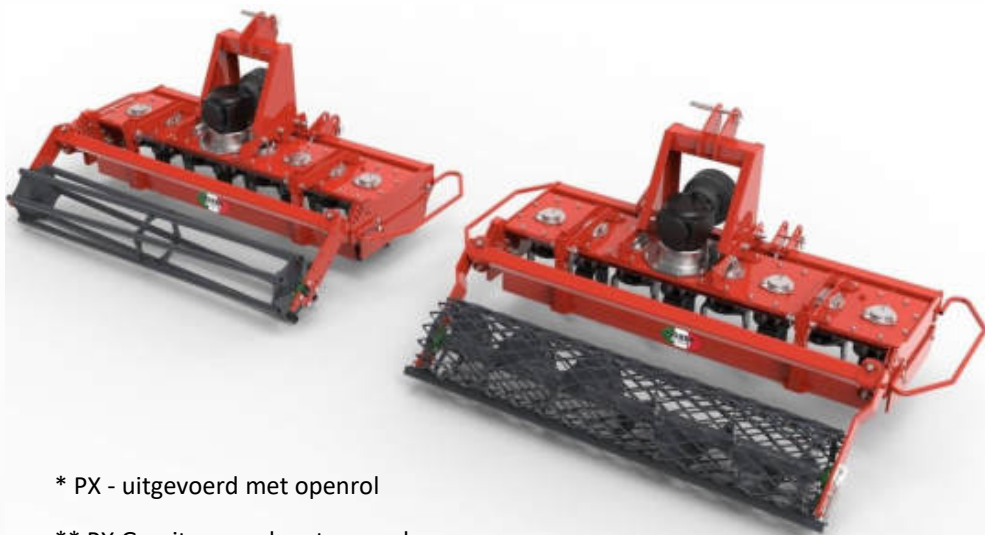

* PX - uitgevoerd met openrol

** PX G - uitgevoerd met gaasrol

PX

								
PX 135	135	540	25 - 40	CAT. II	280	12	2.675,-	
PX 135 G	135	540	25 - 40	CAT. II	280	12	2.915,-	
PX 175	175	540	35 - 65	CAT. II	330	16	3.075,-	
PX 175 G	175	540	35 - 65	CAT. II	330	16	3.350,-	
PX 210	210	540	45 - 75	CAT. II	390	20	3.570,-	
PX 210 G	210	540	45 - 75	CAT. II	390	20	3.895,-	

ZAAICOMBINATIE









Säkombination • Combinaison de Semis • Sowing combination



* Alleen te gebruiken voor graszaad

G
R
O
N
D
B
E
W
E
R
K
I
N
G

ZM









									
ZM 145	145	10 - 15	540	20 - 35	CAT. I/II	536	7	5.170,-	
ZM 165	165	10 - 15	540	25 - 40	CAT. I/II	577	8	5.320,-	
ZM 180	180	10 - 15	540	30 - 50	CAT. I/II	624	9	5.530,-	
ZM 200	200	10 - 15	540	40 - 65	CAT. I/II	662	10	5.650,-	

ZAAICOMBINATIE

Säkombination • Combinaison de Semis • Sowing combination



SB Z

								
SB 125 Z	125	540	20 - 30	CAT. I	480	24	4.880,-	
SB 145 Z	145	540	25 - 40	CAT. I	525	28	5.320,-	
SB 165 Z	165	540	30 - 60	CAT. I	570	32	5.950,-	









OVERTOPFREES

Bodenumkehrfräse • Enfouisseur • Stone burier



G
R
O
N
D
B
E
W
E
R
K
I
N
G

SB

									
SB 125	125	135	540	20 - 30	CAT. I	355	24	2.475,-	
SB 145	145	155	540	25 - 40	CAT. I	380	28	2.595,-	
SB 165	165	175	540	30 - 60	CAT. I	405	32	2.905,-	

Losse slijtonderdelen:



Freesmes p.st. € 7,50

Artikelcode: SB001L (Links)









SB001R (Rechts)

OVERTOPFREES

Bodenumkehrfräse • Enfouisseur • Stone burier



SB HD

								
SB 230HD	230	256	540	80 - 110	CAT. II	590	66	5.950,-

Losse slijtonderdelen:



Freesmes p.st. € 9,50

Artikelcode: SB001AL (Links)

SB001AR (Rechts)

GRONDFREES

Bodenfräse • Fraise rotative • Rotary tiller



G
R
O
N
D
B
E
W
E
R
K
I
N
G

GF

GF 95		90	540	16 - 25	CAT. I	130	15	4 x 4	1.350,-
GF 115		115	540	18 - 30	CAT. I	140	15	6 x 4	1.475,-
GF 125		125	540	20 - 30	CAT. I	145	15	7 x 4	1.615,-
GF 150		150	540	25 - 50	CAT. I	270	15	8 x 4	1.805,-

Losse slijtonderdelen:



Freesmes p.st. € 7,50

Artikelcode: GF002 (links)

GF003 (rechts)

GRONDFREES

Bodenfräse • Fraise rotative • Rotary tiller



GF T

GF 125 T	125	540	18 - 30	CAT. I	285	15	6 x 6	2.175,-
GF 150 T	150	540	25 - 50	CAT. I	300	15	7 x 6	2.250,-
GF 180 T	180	540	35 - 75	CAT. I/II	350	15	8 x 6	2.350,-

Losse slijtonderdelen:



Freesmes p.st. € 7,50

Artikelcode: GF002 (links)

GF003 (rechts)

GRONDFREES

Bodenfräse • Fraise rotative • Rotary tiller

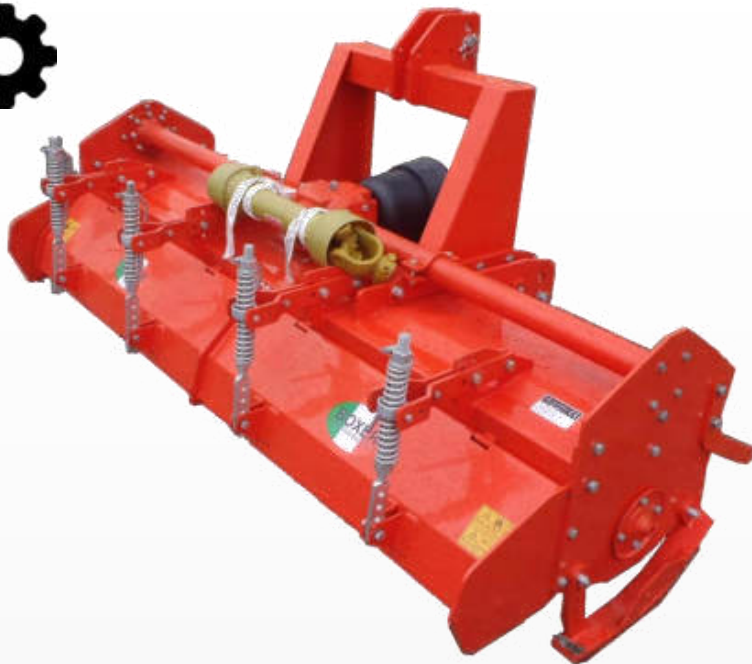

G
R
O
N
D
B
E
W
E
R
K
I
N
G

GF TA

GF 180 TA		180	540	45 - 80	CAT. II	505	16	8 x 6	3.225,-
GF 200 TA		200	540	50 - 85	CAT. II	540	16	9 x 6	3.350,-
GF 220 TA		220	540	60 - 90	CAT. II	575	16	10 x 6	3.450,-

Losse slijtonderdelen:



Freesmes p.st. € 7,50

Artikelcode: GFT220L (links)

GFT220R (rechts)

GRONDFREES

Bodenfräse • Fraise rotative • Rotary tiller

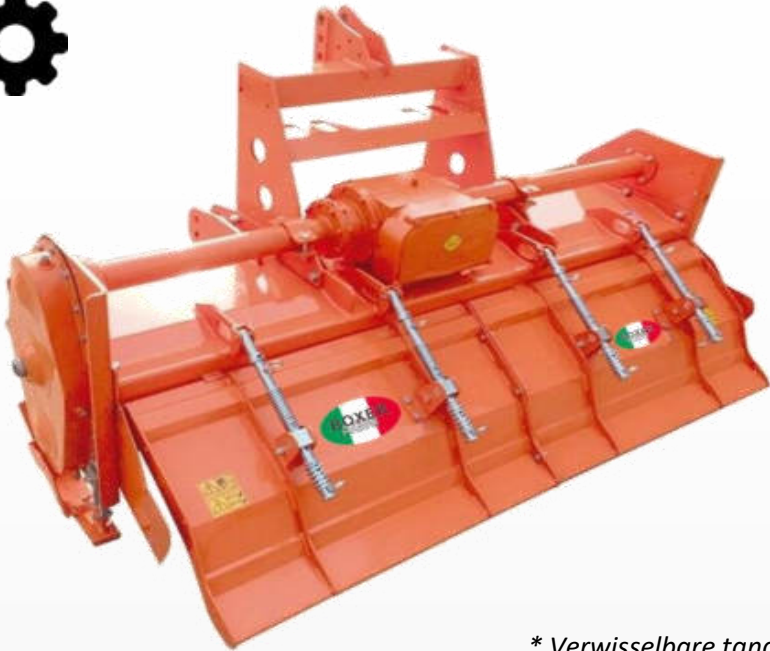

* Verwisselbare tandwielen

GF TCA

GF 230 TCA		230	540	80 - 110	CAT. II	645	16	10 x 6	4.820,-
GF 250 TCA		250	540	90 - 120	CAT. II	690	16	11 x 6	4.920,-

Losse slijtonderdelen:



Freemes p.st. € 7,50

Artikelcode: GFT220L (links)

GFT220R (rechts)









GRONDFREES

Bodenfräse • Rotavaters • Rotary tiller



G
R
O
N
D
B
E
W
E
R
K
I
N
G

GF XL

									
GF 250 XL	250	540	80 - 130	CAT. II	980	20	9 x 6	6.450,-	
GF 280 XL	280	540	90 - 150	CAT. II	1050	20	11 x 6	7.125,-	
GF 300 XL	300	540	100 - 160	CAT. II	1250	20	12 x 6	7.750,-	

Losse slijtonderdelen:



Freesmes p.st. € 7,50

Artikelcode: GFXL001 L (links)

GFXL002 R (rechts)

SLEUVENFREES

Schlitzfräse • Trancheuse • Ditcher



* D0 2 - vaste bok

* D0 3 - bok met cilinder

MAX. 300 - 500 MTR/H

D0

D0 2	8 - 16	65	540	70 - 120	CAT. II	450	16	4.950,-
D0 3	8 - 16	75	540	100 - 150	CAT. II	580	18	5.950,-

Losse slijtonderdelen:



Messen p.st. € 12,70

Artikelcode: GRE05.012 (links)

GRE05.013 (rechts)

Messen met slijtlaag p.st. € 19,75

Artikelcode: GRE05.014 (links)

GRE05.015 (rechts)

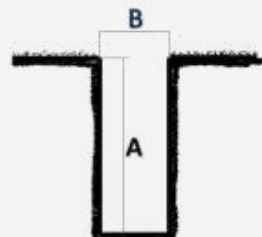

GREPPELFREES

Grabenfräse • Terrasseur • Ditcher



MAX. 600 - 1000 MTR/H

G
R
O
N
D
B
E
W
E
R
K
I
N
G

GREP

GREP 90	15 - 90	70	540	60 - 100	CAT. II	400	3.850,-

Losse slijtonderdelen:

Mesplaat p.st. € 6,60

Artikelcode: GRE00.130

Freesmes recht p.st. € 14,60

Artikelcode: GRE030.040

Freesmes haaks p.st. € 14,60

Artikelcode: GRE030.041

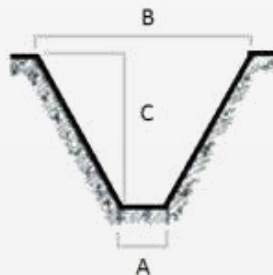

A - 15 cm

B - 90 cm

C - 70 cm

GREPPELFREES

Grabenfräse • Terrasseur • Ditcher



MAX. 0 - 3 KM/H

FG

FG 110	12 - 47	45	540	70 - 130	CAT. II	520	5.250,-

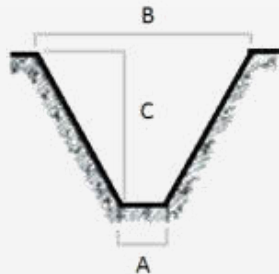

A - 12 cm

B - 47 cm

C - 45 cm

Losse slijtonderdelen:



Freesmes p.st. € 17,10

Artikelcode: FGH1K65101 (links)

FGH1K60102 (rechts)

AARDAPPELPOOTMACHINE

Kartoffel Pflanzler • Planteuse de pdt • Potato planting machine



AP1

AP 1	25 - 40	80	540	15 - 30	CAT. I	94	1.215,-











AARDAPPELROOIER

Kartoffelvorratsroder • Arracheuse de pdt • Potato harvest machine



PD50





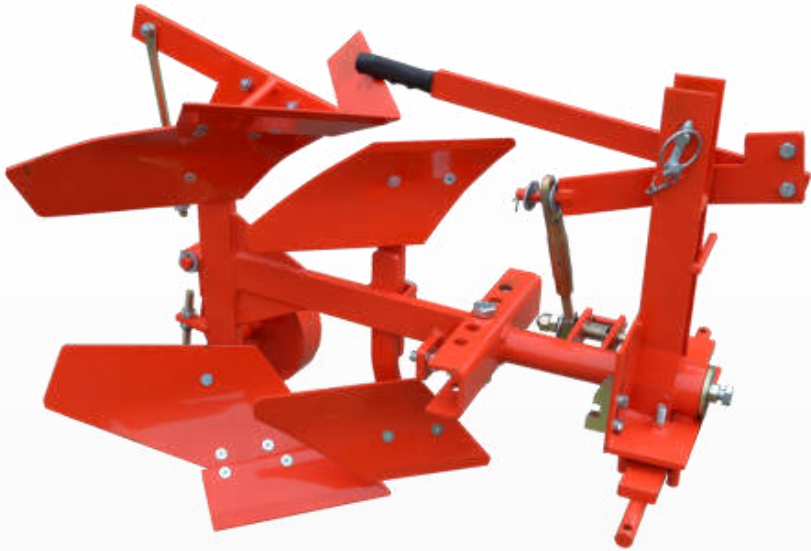

							
PD 50	50	70	540	15 - 30	CAT. I	175	1.495,-

PLOEG

Pflüge • Charrues • Plough



FZL

					
FZL	20	20 - 25	CAT. I	110	950,-







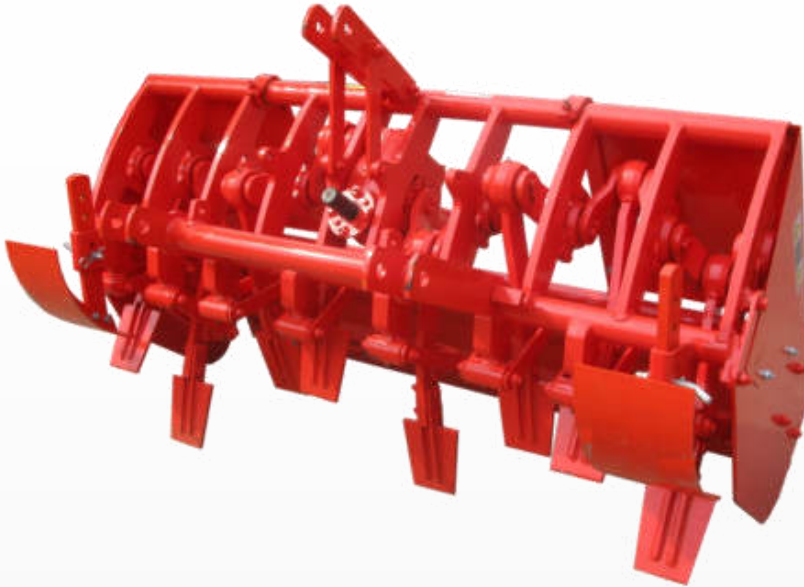

SPITMACHINE

Spatenmaschinen • Machine à bêcher • Spading machine



DM

				 HP			
DM 110		90	20	20 - 40	CAT. I	210	3.085,-
DM 140		120	20	40 - 60	CAT. I	250	3.420,-

Losse slijtonderdelen:



Spitmes p.st. € 41,-
Artikelcode: DMHNX100018

GRONDBOOR

Bohregerät • Tarière • Post hole digger

G
R
O
N
D
B
E
W
E
R
K
I
N
G



B152



B228



B305



B355



GB3P

UNIT - GB3P	540	CAT. I	1.725,-

B 152	15,2	100	350,-
B 228	22,8	100	360,-
B 305	30,5	100	380,-
B 355	35,5	100	395,-



WS400
WS500

BODEMVLAKKERS & WEIDESLEPEN
REITBAHNPLANER & WIESENSCHLEPPE
HERSE NIVELEUSE & HERSE DE PRAIRIE
MANEGE RAKE & GRASS HARROW







WEIDESLEEP

Wiesenschleppe • Herse de prairie • Grass harrow



WS135
WS150
WS200

WS

						
WS 135	135	CAT. 0/I	100	-	11	655,-
WS 150	150	CAT. I	120	-	14	705,-
WS 200	200	CAT. I/II	180	-	17	775,-
WS 400	400	CAT. II	260	Mech.	38	1.490,-
WS 500	500	CAT. II	300	Mech.	46	1.700,-

Losse slijtonderdelen:



Ster p.st. € 9,50
Artikelcode: WS001



Bevestigingsring 80 mm / 125 mm:
Artikelcode: WS002 - p.st. € 2,70
WS003 - p.st. € 3,30



V
L
A
K
K
E
R
-
W
E
I
D
E
S
L
E
E
P

LANDLEVELLER

Landleveller • Niveleur de terrain • Land Level



LL







(M)			kg	€
LL 150	148	160	219	1.785,-
LL 210	208	220	257	2.090,-

BODEMVLAKKER

Reitbahnplaner • Herse Niveleuse • Manege rake



EE

						
EE 120	120	CAT. I	50	7	11	1.120,-
EE 200	200	CAT. I	60	11	17	1.250,-

Losse slijtonderdelen:



Veertand licht p.st. € 5,25
Artikelcode: EE/002









Veertand zwaar p.st. € 17,50
Artikelcode: EE/001

BODEMVLAKKER

Reitbahnplaner • Herse Niveleuse • Manege rake



EE ATV

						
EE 120 ATV	120	ATV	50	7	11	1.225,-
EE 200 ATV	200	ATV	60	11	17	1.425,-

Losse slijtonderdelen:



Veertand licht p.st. € 5,25
Artikelcode: EE/002









Veertand zwaar p.st. € 17,50
Artikelcode: EE/001

BODEMVLAKKER

Reitbahnplaner • Herse Niveleuse • Manege rake



PISTE PROFI

					
PISTE 140	140	CAT. I	260	6 + 9	2.100,-
PISTE 170	170	CAT. I/II	305	8 + 11	2.275,-
PISTE 220	220	CAT. I/II	350	10 + 14	2.460,-
PISTE 260	260	CAT. II	400	12 + 17	2.825,-

Losse slijtonderdelen:

Veertand voor p.st. € 4,75 - artikelcode: PID002

Veertand achter p.st. € 4,75 - artikelcode: PID003



TERREIN- EN WEGENBEHEER
KOMMUNALMASCHINEN
MACHINES MUNICIPALES
MUNICIPAL MACHINERY

ZOUTSTROOIER

Dunger & Salzstreuer • Saleuse & semoir • Salt & fertilizer spreader



ZS



ZS 160



500



160



5,5



90



760,-

T
E
R
R
E
I
N
&
W
E
G
E
N
B
E
H
E
R
E
R

ZOUTSTROOIER

Salzstreuer • Saleuse • Salt spreader



TS

TS 250	1600	250	540	20 - 50	CAT. II	80	1.740,-

SNEEUWSCHUIF

Schneeräumschild • Lame à neige • Snow blade



* Verkrijgbaar in CAT. I (3 punts aansluiting), EURO- of W- aansluiting

SS

(M)			(C)			(€)
SS 1400	140	86	CAT. I EUR. / W	25 - 70	126	1.475,-
SS 1600	160	86	CAT. I EUR. / W	25 - 70	140	1.525,-
SS 1800	180	86	CAT. I EUR. / W.	25 - 70	155	1.585,-
SS 2000	200	86	CAT. I EUR. / W.	25 - 70	170	1.640,-
SS 2200	220	86	CAT. I EUR. / W.	25 - 70	190	1.690,-
SS 2400	240	86	CAT. I EUR. / W.	25 - 70	210	1.805,-
SS 2500	250	86	CAT. I EUR. / W.	25 - 70	230	1.835,-

T
E
R
R
E
I
N
&

W
E
G
E
N
B
E
H
E
R

SNEEUWSCHUIF

Schneeräumschild • Lame à neige • Snow blade



PU



PU 2600



230 - 260

99



CAT. II/III



80 - 150



660



4.350,-

SNEEUWSCHUIF

Schneeräumschild • Lame à neige • Snow blade



PUV

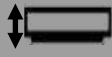

PU 3300V

270 - 330

99

CAT. II/III

80 - 150

680

5.325,-

T
E
R
R
E
I
N
&
W
E
G
E
N
B
E
H
E
R

SNEEUWSCHUIF

Schneeräumschild • Lame à neige • Snow blade



SSV

(M)		(C)			(€)
SSV 220	205 - 220 75	CAT. II	50 - 100	360	2.550,-
SSV 250	225 - 250 75	CAT. II	50 - 100	400	2.735,-
SSV 300	262 - 300 75	CAT. II	50 - 100	480	2.820,-







VEEGMACHINE

Kehrmachine • Balayeuse • Sweeper



* Aftakas aangedreven

VM

						
VM 115	115	540	40 - 50	CAT. I	300	2.535,-
VM 150	150	540	40 - 50	CAT. II	350	2.870,-
VM 190	190	540	40 - 50	CAT. II	400	3.330,-

VEEGMACHINE

Kehrmachine • Balayeuse • Sweeper



*Hydraulisch aangedreven

VM XL

(M)		∅	Ltr/min 	(C)	(€)
VM 260 XL	260	80	35 - 80	CAT. II	6.480,-
VM 290 XL	290	80	35 - 80	CAT. II	6.675,-

ONKRUIDBORSTEL

Unkrautbürste • Brosse à mauvaises herbes • Weed brush



OB

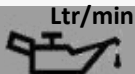

OB 70

70

20 - 90

W / EUR.

150

2.820,-

T
E
R
R
E
I
N
&
W
E
G
E
N
B
E
H
E
R



AANBOUWDELEN / DIVERSE
ANLAGE / VERSCHIEDENE
ACCESSOIRES / DIVERSES
ATTACHMENTS / OTHER

PUINBAK

Gitterschaufel • Seau en pierre • Stone bucket



W PB

(M)		(C)	(€)
W10 PB1092	110	W.	1.160,-
W11 PB1296	130	W.	1.250,-
W12 PB1476	148	W.	1.360,-
W12E PB1476	148	EUR.	1.360,-
W13 PB1596	160	W.	1.460,-
W13E PB1596	160	EUR.	1.460,-

A
A
N
B
O
U
W
D
E
L
E
N

D
I
V
E
R
S
E

TEGELRIEK

Steingabel • Fourchette en pierre • Stone fork



TR

					
TR 122W	122	W.	141	16	1.055,-
TR 150	150	W.	193	19	1.450,-

4 IN 1 BAK

4-1 Mulde • 4-1 Bac • 4-1 box



A
A
N
B
O
U
W
D
E
L
E
N

4-1 FT

(M)		(C)		(€)
4-1 FT254	145	EUR.	210	1.220,-
4-1 FT404	170	EUR.	230	1.320,-







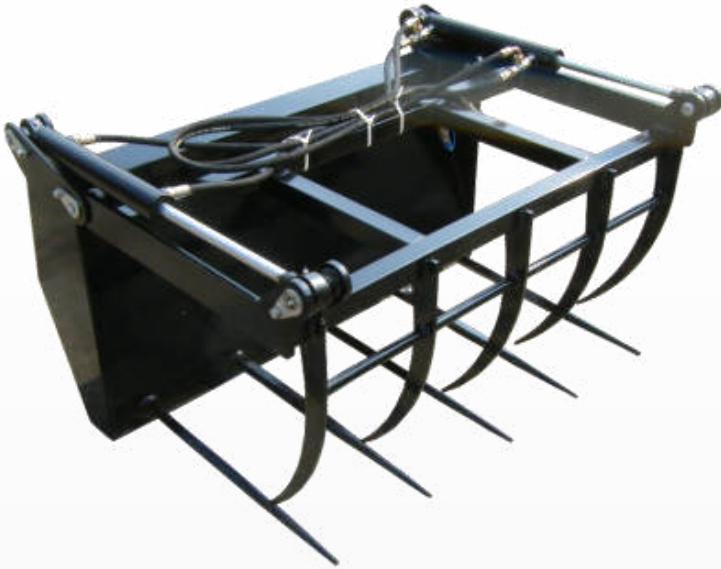

D
I
V
E
R
S
E

MESTVORK

Krokoschauffel • Fourche Crocodile • Manure fork



MG

					
MG 25	70	110	EUR.	210	1.725,-



HYDRAULISCHE KLEM

Hydraulische Klemme • Pince hydraulique • Hydraulic gripper

A
A
N
B
O
U
W
D
E
L
E
N



BK

D
I
V
E
R
S
E



BK 150

90 - 170

130

EUR.

13 - 16

180

1200

1.125,-



HYDRAULISCHE KLEM

Hydraulische Klemme • Pince hydraulique • Hydraulic gripper



BKV

					
BKV 193W	100 - 193	W.	273	800	1.675,-
BKV 193E	100 - 193	EUR.	273	800	1.675,-

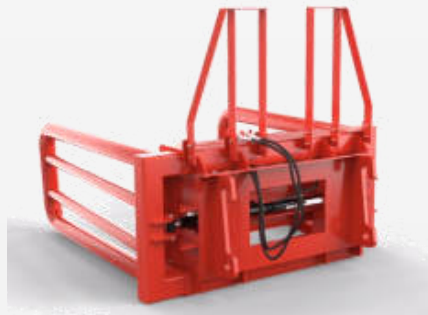

PELIKAANBAK







Greifschaukel • Bac pélican • Silage grab



A
A
N
B
O
U
W
D
E
L
E
N

PB

D
I
V
E
R
S
E

						
PB 110W	110	440	W.	285	4	1.785,-
PB 120W	120	485	W.	296	4	1.825,-
PB 140W	140	570	W.	317	4	1.930,-
PB 140E	140	570	EUR.	317	4	1.930,-
PB 160E	160	660	EUR.	348	5	2.055,-

HOUTKLEM

Zurkette • chaîne d'arrimage • Wood clamp



HK

(M)					(C)		(€)
HK 76E	74	76	107	76	EUR.	175	1.465,-
HK 76W	74	76	107	76	W.	175	1.465,-



BOSBOUW
HOLZBAU
TRAVAIL DU BOIS
FORESTRY

HOUTVERSNIJPERAAR

Holzhäcksler • Broyeur de Bois • Wood chipper



HV

						
HV 106	10	540	18 - 50	CAT. I	196	1.475,-

Losse slijtonderdelen:



Ondermes p.st. € 36,-

Artikelcode: HVH42WCX50102



Rotormes p.st. € 42,50

Artikelcode: HVH42WCX50101

HOUTVERSNIJPERAAR

Holzhäcksler • Broyeur de Bois • Wood chipper



B
O
S
B
O
U
W

WCL



CAP.



WCL 8

20

8 - 9 m³/h

540

25 - 50

CAT. I

260

2.485,-

Losse slijtonderdelen:



Ondermes p.st. € 28,50

Artikelcode: WC/24PMF0110A



Rotormes p.st. € 35,-

Artikelcode: WC/24PMF0110

HOUTVERSNIJPERAAR

Holzhäcksler • Broyeur de Bois • Wood chipper



HV

HV 132	13,2	540 - 1000	25 - 65	CAT. I/II	388	4.515,-

Losse slijtonderdelen:



Ondermes: p.st. € 36,-
Artikelcode: HVK1012M204



Rotormes: p.st. € 42,50
Artikelcode: HVK1012M203







HOUTVERSNIPPERAAR

Holzhäcksler • Broyeur de Bois • Wood chipper



B
O
S
B
O
U
W

HV

						
HV 157	15	540 - 1000	30 - 100	CAT. II	485	4.360,-
HV 233	25	540 - 1000	65 - 100	CAT. II	650	5.955,-

Losse slijtonderdelen:

Onder mes p.st. € 36,-

Artikelcode: HVC157002

Rotor mes p.st. € 42,50

Artikelcode: HVC157001

HOUTVERSNIJPERAAR

Holzhäcksler • Broyeur de Bois • Wood chipper



HV



HV 285



28,5



540 -
1000



85 - 125



CAT. II



875



8.225,-







HOUTVERSNIJPERAAR

Holzhäcksler • Broyeur de Bois • Wood chipper



B
O
S
B
O
U
W

MHV

					
MHV 15	15	15	EURO 95	285	3.925,-

Losse slijtonderdelen:

Onder mes p.st. € 47,50

Artikelcode: MHV003

Rotor mes p.st. € 45,-

Artikelcode: MHV002

HOUTKLOVER

Holzspalter • Fendeuse de bûches • Log splitter









LSP 22T-110



LSP22T

LS

		<u>CAP.</u>		 HP			
LSP 22T	35	22 TON	540	15 - 55	CAT. I	210	2.205,-
LSP 22T-110	35	22 TON	540	15 - 55	CAT. I	210	2.305,-

Werkpositie - vertical
 Arbeitsstellung - vertikale
 Position de travail - vertical
 Working position - vertical

LSP22T - Afmeting: 102x38x190 cm
 LSP22T-110 - Afmeting: 102x38x275 cm
 (Max. hoogte mes 106 cm)

BOMENFREES

Forst Wirt Schaft Mulcher • Broyeur Forestiers • Forestry mulcher



B
O
S
B
O
U
W

BM

BM 180	180	12	540 - 1000	60 - 70	CAT. II	900	36	6.250,-	
BM 230	230	12	540 - 1000	70 - 80	CAT. II	1000	46	6.500,-	

Losse slijtonderdelen:

Hamerklepel p.st. € 17,50

Artikelcode: BMH001











BOMENFREES

Forst Wirtschaft Mulcher • Broyeur Forestiers • Forestry mulcher



BM HD

								
BM 180 HD	180	20	1000	90 - 130	CAT. II	1400	30	11.850,-
BM 200 HD	200	20	1000	100 - 140	CAT. II	1500	32	12.285,-
BM 220 HD	225	20	1000	110 - 160	CAT. II	1593	36	13.200,-

Losse slijtonderdelen:

Beitel p.st. € 94,50

Artikelcode: FRM225. 1-2



HYDRAULISCHE BOMENFREES

Forstmulcher für Bagger • Broyeur Forestiers pour pelle • Forestry mulcher for excavators



B
O
S
S
B
O
U
W

EFM

			 Ltr/min	 t.		 kg		
EFM 800	80	38 - 80	6 - 8	250	450	16	7.990,-	





KIPWAGEN
ANHÄNGER
REMORQUES
TRAILER

KIPWAGEN

Anhänger • Remorques • Trailer



HT 15



HT 25









HT 25/4

* Off road use only

K
I
P
W
A
G
E
N
S

HT

			 HP		 kg	 kg	
HT 15	240X110X40	14 - 25	40°	250	1500	1.995,-	
HT 25	240X125X40	20 - 50	45°	300	1500	2.860,-	
HT 25/4	240X125X40	20 - 50	45°	320	2500	2.915,-	



HT 15 - 20X10.00-8

HT 25 - 185R14

HT 25/4 - 20X10.00-8

KIPWAGEN

Anhänger • Remorques • Trailer









HT 30

HT 30-3Z

** Off road use only*

HT

		 HP		 kg	 kg	
HT 30	250X150X40	20 - 50	45°	300	3000	4.175,-
HT 30-3Z *	250X150X40	20 - 50	45°	300	3000	4.865,-



10.5X15

** HT 30-3Z : 3 zijdig • 3 sided*



GRAAFMACHINES
BAGGER
PELLE
EXCAVATOR

ACHTERLADER

Heckbagger • Rétrocaveuse • Backhoe











AL MINI

* hydraulische side shift



AL 195

AL

					 HP	 kg	 Ltr.	
AL mini	30	540	CAT. I	18 - 25	270	18	4.075,-	
AL 195	30	540	CAT. I	30 - 45	540	18	4.875,-	

	A	B	C	D
AL mini	95	244	228	128
AL 195	290	195	317	200

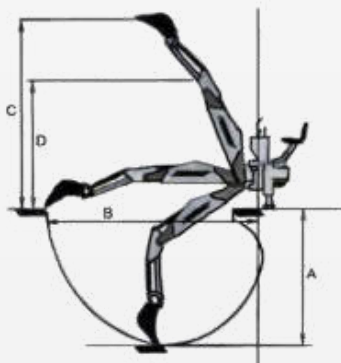

GRAAFMACHINE

Bagger • Pelle • Excavator



ME15

Gewicht	Gewicht	Poids	Weight	590 Kgs.
Breedte	Breite	Largeur	Width	720 mm
Hoogte	Höhe	La taille	Height	2000 mm
Rotatie arm	Dreharm	Bras de rotatin	Rotation arm	360
Motor	Motor	Moteur	Engine	B&S 13.5 HP, monocylinder, 4 stroke
Benzinetank capaciteit	Treibstofftank Kapazität	Capacité du réservoir de carburant	Fuel tank capacity	6,6 ℓ
Olietank capaciteit	Öltankkapazität	Capacité du réservoir d'huile	Oil tank capacity	23 ℓ
Pomp	Pumpe	Pompe	Pump	3,2 cc Gear pump
Werkdruk	Arbeitsdruck	Pression de travail	Working pressure	160 bar
Olieopbrengst	Ölausbeute	rendement en huile	Flow	6,4 ℓ/min
Prijs	Preis	Prix	Price	€ 9.385,-*

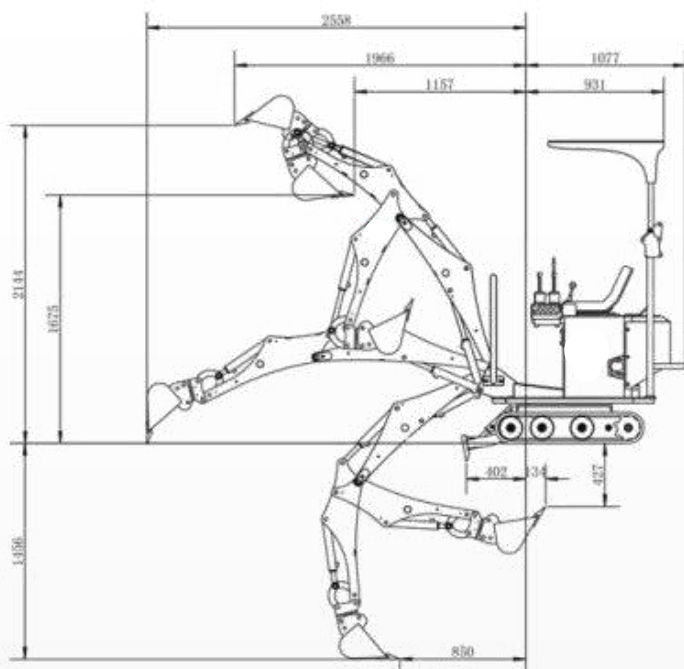

*** Inclusive:**



Bucket
BHB200



Bucket
BHB300



Bucket
BHB600

Exclusive:



Rock Grabber
RB60
€ 295,-



Auger
€ 950,-

GRAAFMACHINE

Bagger • Pelle • Excavator





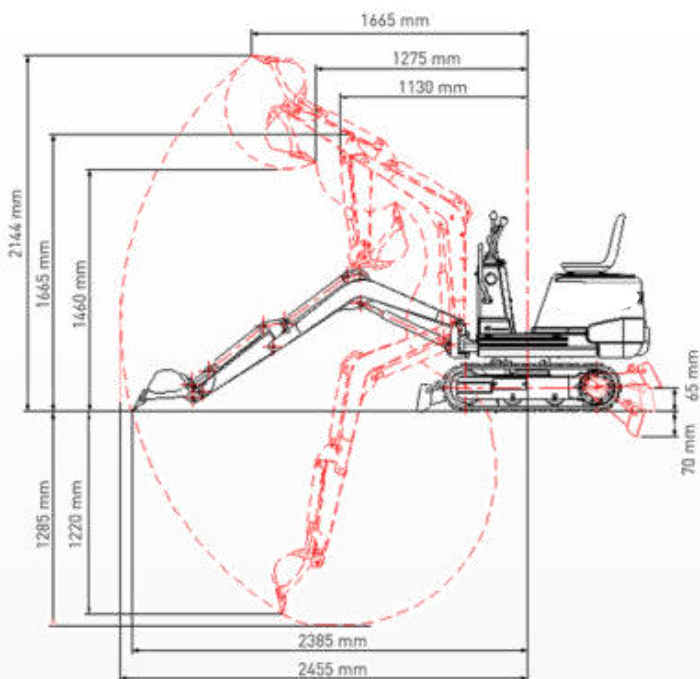

HSW06G















Lengte	Länge	Longueur	Length	243 cm
Breedte	Breite	Largeur	Width	73 cm
Hoogte	Höhe	La taille	Height	118 cm
Gewicht	Gewicht	Poids	Weight	715 Kgs.
Wielbasis	Radstand	Empattement	Wheelbase	79 cm
Bodemvrijheid	Bodenfreiheit	Garde au sol	Ground clearance	15 cm
Breedte van de rups	Kettenbreite	Largeur des chenilles	Width of track shoe	15 cm
Rotatie arm	Dreharm	Bras de rotatin	Rotation arm	360 °
Rijsnelheid	Fahr-geschwindigkeit	Vitesse de conduite	Traveling speed	1.32 Km/h
Max. graafdiepte	Grabtiefe	profondeur de creusement	Max digging depth	129 cm
Prijs	Preis	Prix	Price	€ 9.540,- incl. 1 bak

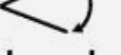
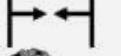

Motor	Motor	Moteur	Engine	B&S 19N1 11 HP, gasoline engine
Cylinder / slag	Zylinderhub	Course du cylindre	Cylinder/stroke	82/58 mm
Totale uitlaat van de cilinder	Gesamt- absaugung des zylinders	Échappement total du cylindre	Total exhaust of cylinder	0.306 L
Nominale snelheid	Nenndrehzahl	Vitesse nominale	Rated Speed	3600 r/min
Hoofdpomp	Hauptpumpe	Pompe principale	Main pump	Gear pump 2x 2,5 ℓ
Werkdruk	Arbeitsdruck	Systeme de demarage	Rated presseure	195 bar
Benzinetank capaciteit	Treibstofftank Kapazität	Capacité du réservoir de carburant	Fuel tank capacity	3,5 ℓ
Olietank capaciteit	Öltankkapazität	Capacité du réservoir d'huile	Oil tank capacity	7,5 ℓ

				
	MACHINE MODEL	MASCHINEN-MODELL	MODÈLE DE MACHINE	MACHINE MODEL
	WERK-BREEDTE CM	ARBEITS BREITE CM	LARGEUR TRAVAILLE CM	WORKING WIDTH CM
	MACHINE BREEDTE CM	MASCHINE BREITE CM	LARGEUR MACHINE CM	MACHINE WIDTH CM
	MACHINE HOOGTE CM	MASCHINE HÖHE CM	HAUTEUR MACHINE CM	MACHINE HEIGHT CM
	CAPACITEIT M3	KAPAZITÄT M3	CAPACITÉ M3	CAPACITY M3
	CAPACITEIT LTR.	KAPAZITÄT LTR.	CAPACITÉ LTR.	CAPACITY LTR.
	AFMETINGEN CM	ABMESSUNGEN CM	DIMENSIONS CM	SIZE CM
	KIEPHOOGTE CM	SCHÜTTHÖHE CM	TIPPING HAUTEUR CM	DUMP CLEARANCE CM
	WERKDIEPTE CM	ARBEITSTIEFE CM	PROFONDEUR CM	TILLING DEPTH CM
	SLEUFBREEDTE CM	SCHLITZ/ HOLE BREITE CM	LARGEUR CM	SLOT / BORE WIDTH CM
	MAAIHOOGTE CM	SCHNITTHÖHE CM	COUPE HAUTE CM	CUTTING HEIGHT CM
	HOUT LENGTE CM	HOLZLÄNGE CM	LONGUEUR DU BOIS CM	WOOD LENGTH CM
	INKLAPBAAR	ZUSAMMEN KLAPPBAR	PLIABLE	FOLDING
	KIEPHOEK °	KIPWINKEL °	ANGLE D'INCLINAISON °	TIPPING ANGLE °
	DOORSNEDE WERKBREEDTE CM	ARBEITS BREITE CM	DIAMÈTRE A COUPE TRANS-VERSALE CM	DIAMETER WORKING WIDTH CM
	AFMETING HOOIBAAL CM	ABMESSUNGEN BALE CM	TAILLE DE BALLE DE FOIN CM	SIZE BALE CM
	OPENINGS-HOOGTE CM	ÖFFNUNGSHÖHE CM	HAUTEUR DE OUVERTURE CM	OPENING HEIGHT CM
	BAR N.	DRÜCKEN N.	PRESSAGE N.	PRESSING N.



 Ltr	OLIE LTR.	ÖL LTR.	HUILE LTR.	OIL LTR.
 Ltr/min	VERBRUIK OLIE PER MINUUT	GEBRAUCH OL PRO MINUTE	USAGE HUILE PAR MINUTE	USAGE OIL PER MINUTE
	AFTAKAS TOERENTAL RPM	ZAPFWELLEN- DREHZAHL RPM	PRISE DE FORCE RPM	PTO SPEED RPM
 HP	BENODIGD VERMOGEN HP	EMPFOHLENE NETZ HP	EXIGENCE DE PUISSANCE HP	RECOMMENDED POWER HP
 HP	BENODIGD VERMOGEN HP	EMPFOHLENE NETZ HP	EXIGENCE DE PUISSANCE HP	RECOMMENDED POWER HP
 HP	BENODIGD VERMOGEN HP	EMPFOHLENE NETZ HP	EXIGENCE DE PUISSANCE HP	RECOMMENDED POWER HP
 HP	BENODIGD VERMOGEN HP	EMPFOHLENE NETZ HP	EXIGENCE DE PUISSANCE HP	RECOMMENDED POWER HP
	CATEGORIE AANSLUITING	KATEGORIE	CATÉGORIE ATACHES	CATEGORY
	BANDENMAAT	REIFEN GRÖßE	LARGEUR ROUES	TYRE SIZE
 kg	GEWICHT KG	GEWICHT KG	POIDS KG	WEIGHT KG
 kg	DRAAG- VERMOGEN KG	TRAGFÄHIGKEIT KG	PORT EN LOURD KG	DEADWEIGHT KG
	STROOI- BREEDTE CM	STREUBREITE CM	LARGEUR EPANDAGE CM	SPREADING WIDTH CM
	DRUKKRACHT	DRUCK NETZ	FORCE DE PRESSION	WORKING PRESSURE
	KETTING AANDRIJVING	KETTENANTRIEB	TRANSMISSION PAR CHAÎNE	CHAIN TRANSMISSION
	TANDWIEL AANDRIJVING	ZAHNRAD ANTRIEB	TRANSMISSION À PIGNONS	GEAR WHEEL DRIVE
	AANTAL PER SECONDE	ANZAHL PRO SEKUNDE	NOMBRE PAR SECONDE	NUMBER PER SECOND
CAP.	CAPACITEIT	KAPAZITÄT	CAPACITÉ	CAPACITY
	PRIJS EURO EXCL. BTW	PREIS EURO EXCL. MWST	PRIX EURO SANS TVA	PRICE EURO EXCL. VAT



BOXER AGRICULTURE EQUIPMENT

Member of de Heus groep

Stougjesdijk 153 • 3271 KB • Mijnsheerenland
+31 (0) 186 - 612333 • info@boxeragri.nl



NR.22

WWW.BOXERAGRI.NL