

EBS | Innovation since 1977

SPOT ON.



HANDJET EBS-250 EDITION

TOP MARKS

PORTABLE INK-JET PRINTING



Portable Printing. In your Hands.

Crystal Clear
Marking & Coding

The Handjet EBS-250 Edition - A revolutionary, technically innovative hand-held device for portable marking and coding applications.



Reliable printing. For most every surface.

Challenge: The Substrate.

Whatever surface needs to be marked or coded, the Handjet EBS-250 Edition will print precisely and clearly. Concrete, metal, glass, textiles, plastic, cardboard or wood. You name it...the Handjet EBS-250 can mark it.

Simple and versatile.

The Handjet EBS-250 Edition is simple to operate: Messages are imported wirelessly and printed at the push of a button. Wheel guides adapt to the operators hand speed resulting in lightening fast, clear, easy-on-the-eye print.

Clarity.

Many Surfaces – Many Solutions.



→ Rubber printed with white pigmented ink (ethanol); 4-wheel stabilizer.



→ Cut wood printed with black universal ink (ethanol); large spacing wheels.



→ Leather (imitation) printed with blue pigmented ink (MEK).



→ Food Stuffs printed with brown food grade ink (water/ethanol); large spacing wheels.



→ Carpeting printed with black universal ink (ethanol); 4-wheel stabilizer.



→ Aluminium printed with quick-drying ink (acetone); large spacing wheels.

Best results.

The print remains clear and distinct.



→ Concrete printed with special ink for stronger UV resistance; large spacing wheels.



→ Ceramic printed with black universal ink (ethanol); metal spacing wheels for better grip.



→ Cardboard printed with black universal ink (ethanol).



→ Stretch Film printed with black universal ink (ethanol); large spacing wheels.



→ Super Sacks (PE) printed with black quick-drying ink (acetone); large spacing wheels.



→ Tool Steel printed with black universal ink (ethanol); metal spacing wheels for better grip.

High Performance.

Software: Simple.

The Windows™ based user-friendly software includes text, simple graphics, special symbols along with time, date, and counters. Messages are quickly transferred to the printer via wireless Bluetooth®. Up to 1300 characters per message - including a new feature of two lines of print - can be programmed, edited, and printed. The standard EBS-250 Edition stores up to 10 messages, with an optional extended memory that stores up to 30 messages.

Optional: Database

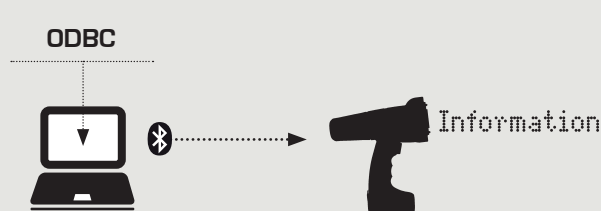

Optional: Scan to Print

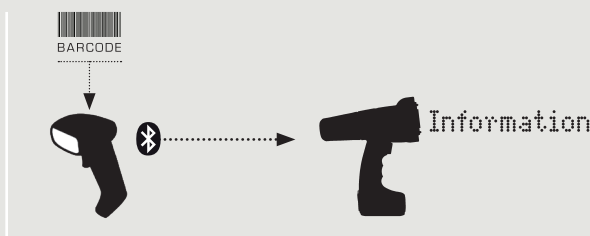

With the EBS-250 Edition
painless portable printing.

EBS' innovative engineering and pioneering imagination make the Handjet a real work horse. Printing heights from 7mm/0.28" (5x5 Matrix) to 27mm/1.06" (16x10 Matrix) give you the most flexibility of any portable printer ever produced.

5x5 7x5 12x7 16x10

High Intensity

Low Intensity

LINE1 LINE1 LINE1
LINE2 LINE2 LINE2

THIR9 32R3VER

NARROW PRINT



>>Database<<

STRETCH PRINT

中国欢迎您!

True Type



T
O
W
E
R
P
R
I
N
T

Practical.

Rough surface? Smooth sailing!

Substrates are a big challenge for any printer, but we make it easy. Round, curved or rough surfaces are easily navigated with the smart, optional stabilizers and guide wheels.

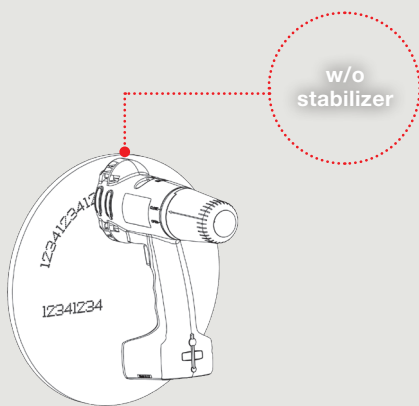

→ **Universal:**
Standard wheels included as standard. Optional: large spacing wheels; metal wheels.

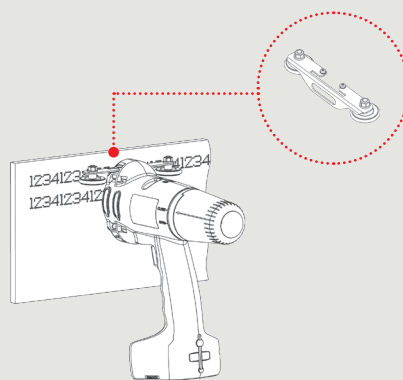

→ **2-wheel stabilizer:**
Optimizes the print result on straight surfaces, for printing in rows.

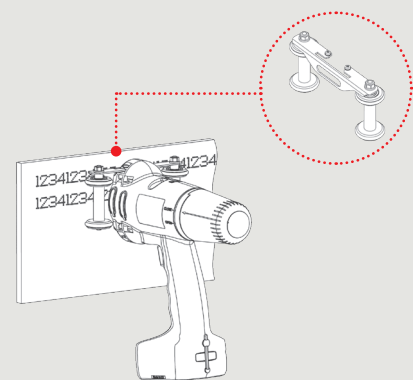

→ **4-wheel stabilizer:**
Good for straight or slightly soft surfaces or when especially smooth/slippery.

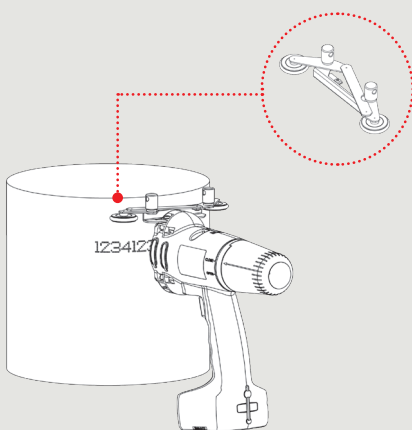

→ **2-wheel scissor-stabilizer:**
Especially for cylindrical objects in the vertical position. Diameter adjustable.

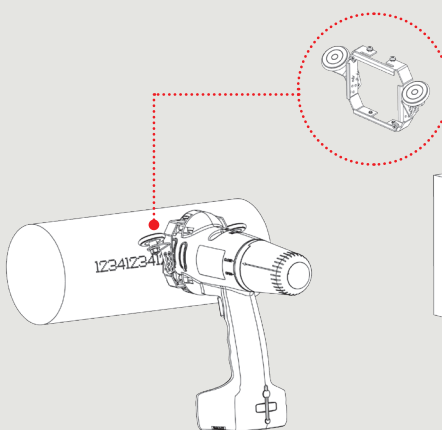

→ **2-wheel frame-stabilizer:**
Makes printing easy on pipes in the horizontal position. There are three distances to choose from.

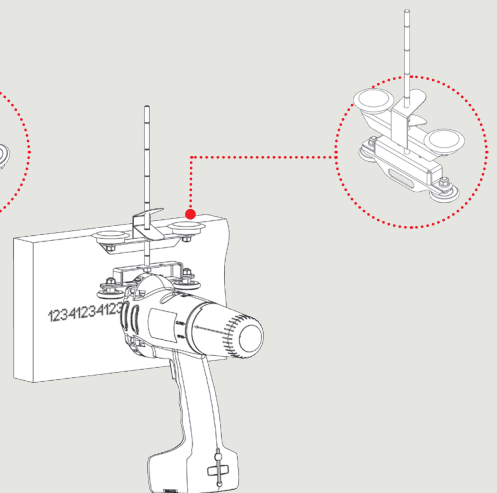

→ **4-wheel spacer:**
Enables especially precise printing of lines via 5 selectable levels from the edge.



So easy.

Hardware: HighTech

Light as a feather, the printer weighs less than a kilogram (2.16 lbs.) including a full cartridge and battery. EBS constantly integrates sophisticated top technology, reducing size but increasing capability.

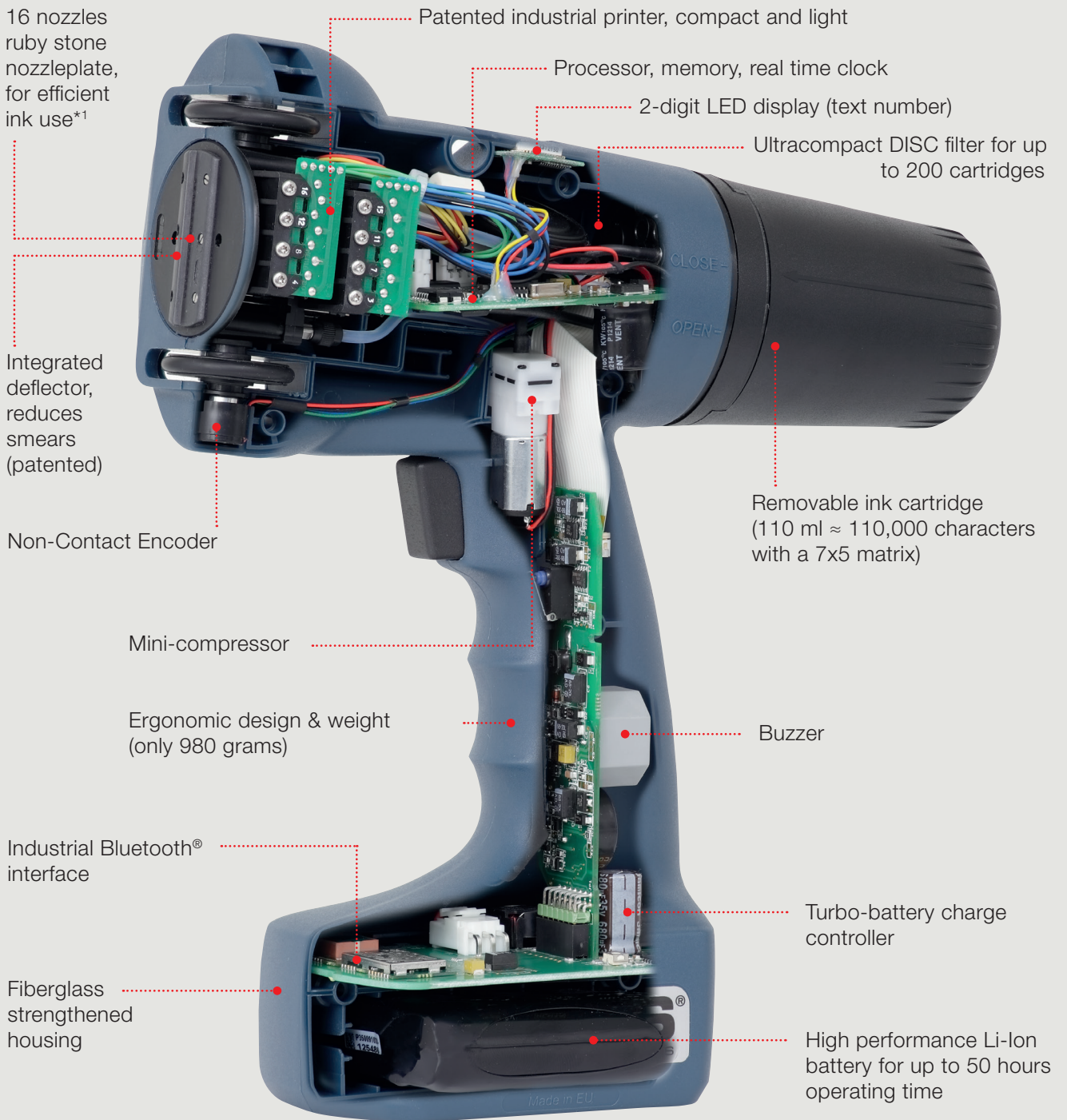

¹ For up to 4x more efficient ink use via optimized nozzle geometry.

So good,



Designed and built by EBS.

Operating the printer couldn't be more comfortable. Data is transferred to the printer via wireless Bluetooth®. The 2-digit display shows the text in use. The function key allows quick change between available texts. The innovative battery management enables constant printing for up to 50 hours per charge.

It prints fast, clean and legible – even over head, all with the pull of the trigger. The intelligent wheel guide adapts automatically to your speed. Error proof printing – easily done.

Here you have the advantages:

- Nearly all surfaces
- Exactly what you want to print - no mess, drips or „extras“
- Quick, efficient and clean
- Light and cable-free
- Intuitive and user-friendly
- No base station required
- Cost effective
- Network up to 20 printers

Rollcoder? Stamps? Stencils? Forget about it!

With the EBS-250 Edition time-consuming printing is a thing of the past. Gone are unreadable, dripping or smudged prints. Regain your independence!

Out with the old...in with the NEW Handjet EBS-250 Edition!



Rollcoder



Marker



Stencil

Shipped.

Standard package.

- Transport case
- Printer HANDJET EBS-250Edition
- Spray bottle (empty)
- Power supply 24V/1A
- CD-ROM with user software and manual
- Industrial Bluetooth® USB-stick



Accessories

- Memory extension 30 textblocks
- Special Software for database transfer to printer
- Scan-to-Print software, on request also in a set with 2D barcode scanner at an attractive price
- Beltbag
- Various stabilisers

For every purpose the right ink¹.

Different surfaces, different areas of operation, different inks:
printing on concrete requires e.g. another ink compared to foodgrade applications. Dark backgrounds require lighter pigmented inks, particularly smooth surfaces require especially quick-drying, adhesive colour.

Inked.

Water · Ethanol · Acetone · MEK



ETHANOL BLUE

Universal ink for almost all surfaces, good contrast on light backgrounds/substrates



ACETONE BLACK

Universal ink for almost all surfaces, quick-drying, good contrast on light backgrounds/substrates



ETHANOL BROWN

Foodgrade ink for printing directly onto foodstuffs or printing of food packaging



ETHANOL BLACK

Universal ink for almost all surfaces, heat-proof up to 250° for up to 40 sec.



WATER RED

for porous surfaces, slight migration (e.g. for wood marking)



ETHANOL RED

Foodgrade ink for printing on food packaging, good contrast



MEK YELLOW, PIGMENTED

Universal ink for almost all surfaces, quick-drying, good contrast on dark backgrounds/substrates



ACETONE WHITE, PIGMENTED

Universal ink for smooth surfaces, quick-drying, good contrast on dark backgrounds/substrates



MEK BLUE, PIGMENTED

Universal ink for almost all surfaces, quick-drying, good contrast on dark backgrounds/substrates

... more inks upon request

¹ The relationship between ink-jet inks and substrates are subject to the laws of chemistry and physics – and naturally has limits. Please contact us for information regarding your specific application.

Specified.

Facts

Number of nozzles	16
Nozzle diameter	150 µm
Print image height	7 mm (0.28") - 27 mm (1.06")
Height of object to be printed	> 35 mm (1.38")
Text separation	selectable in successive lines
Max. number of characters in printer memory	13,000 (including control characters for implemented fonts)
Memory blocks for projects	10, optional 30 (the texts are loaded into the printer via PC)
Special characters	national, diacritical characters, graphical info-, warning and transport characters
Power supply	high performance 3 cell Li-Ion battery
Operating time with full battery	up to 50 hours with non stop printing at + 20°C (68°F), automatic low battery signal
Recharging	intelligent charge control with external charger DC 24V/1A charging time approx. 150 minutes or less
Cartridge volume	110 ml, capacity for > 110,000 characters (matrix 7x5) or 18,000 characters (matrix 16x10)
Operating pressure	0.3 bar up to 0.4 bar with internal mini-compressor
Operating temp. range	from +0,5°C (33°F) to +40°C (104°F)
Storage temp. range	-from +1°C (34°F) to +45°C (113°F) for printer with water ink -from -10°C (14°F) to +45°C (113°F) for printer with acetone or ethanol ink
Humidity	max. 95% without condensation (printing is possible even in the rain, on a dry surface)

Features

Working position of the printer	any
Graphics (Logo, graphical special character)	standardwise texts and graphic symbols can be archived with Windows™-Fonts (True Type emulation). Own pictograms and logos can be created with the graphics editor of the included software (16x80 pixel) or via .bmp file (16x200 Pixel, black and white).
Special register	date, time, expiry date, incremental and decremental counter, universal counter
Printer programming	- wireless connection (range up to 50m/165 feet) - text- and parameter processing software, compatible with Windows™ 7-10 - wireless networking of up to 20 printers, controlled from one single PC
Speed encoder	print output regulated by encoder in the lower guide wheel
Ink	available in easily replaceable cartridges, ink based on ethanol, acetone, MEK or water in different colors. One ink, one Handjet. It is not recommended to change ink type.

EBS | Innovation since 1977



Plant Nümbrecht - Germany

EBS | 43 Years of Competence and Innovation

Since 1977, EBS GmbH Germany has been a leader in industrial coding equipment. Our early development and pioneering innovations in ink-jet technology are still being used world wide.

Today EBS has become an international producer and operates a family owned multi-national business. We run branch offices and plants in Europe, USA and China and co-operate with numerous partner companies world wide.

More than 330 people develop and produce the range of EBS products in Germany and Poland. We continue to set global standards for quality, innovation, technological leadership and service.

Our high performance products can be found in more than 70 countries, with more than 200 distributors, dealers and OEM's.

We would like to welcome you as our new customer.

www.ebs-inkjet.de

Your Dealer

Subject to technical changes.



PRODUCTION & DEVELOPMENT

HEADQUARTERS GERMANY

EBS Ink Jet Systeme GmbH
Alte Ziegelei 19-25
51588 Nümbrecht-Elsenroth
Deutschland
Tel: 0 22 93 / 93 9-0
Fax: 0 22 93 / 93 9-3
E-Mail: mail@ebs-inkjet.de
www.ebs-inkjet.de

POLAND

EBS Ink-Jet Systems Poland Sp.z o.o.
ul. Tarnogajska 13
50-512 Wroclaw (Breslau)
Polen
Tel: (+48) 71 36 70 411
Fax: (+48) 71 37 33 269
E-Mail: office@ebs-inkjet.pl
www.ebs-inkjet.pl

SALES, LOGISTICS & TECHNICAL SUPPORT

USA

EBS Ink-Jet Systems USA, Inc.
1840 Industrial Drive - Suite 200
Libertyville, IL 60048
USA
Tel: (001) 847 996 0739
Fax: (001) 847 996 0843
E-Mail: sales@ebs-inkjet.com
www.ebs-inkjet-usa.com

CHINA

EBS Ink-Jet Systems
(SHENZHEN) Co., Ltd.
Unit 608, Building Jin-Hui-Qiu No.5,
Langshan 2nd Road, Gaoxin bei qu,
Nanshan District
518057 Shenzhen China
Tel: (+86) 755 2340 0676
Fax: (+86) 755 2340 0376
E-Mail: office@ebs-china.com
www.ebs-inkjet-china.com

