



Sûreté des Procédés Industriels

SHORT  
FORM



[www.georgin.com](http://www.georgin.com)

## History

GEORGIN has two areas of expertise : industrial instrumentation and the interfacing of measurement signals in hazardous area.



Marc-Aurèle Andrieux  
Chairman

### Founded by Marcel GeorGIN in 1939

"Les Régulateurs GeorGIN" has grown by gradually diversifying its activities for more than 80 years.

- 1965 : Creation of the Physique department, specialised in measurement and regulation (pressure and temperature)
- 1970 : Creation of the Physelec department, specialised in intrinsic safety relays
- 1993 : Creation of the NDT department (Nuclear – Defense – Transport)
- 2006 : First SIL declaration
- 2012 : Creation of the CIAG Instruments subsidiary in Germany
- 2016 : Opening of GeorGIN Asia Pacific (branch office)
- 2020 : CIAG becomes GeorGIN GmbH (Germany)



### GeorGIN has been well renowned in France and worldwide for more than 80 years

For its expertise in the measurement and control of pressure and temperature, in the processing, conditioning and security of electrical signals, in industry, military shipbuilding, railways and electricity (production and transmission of nuclear, thermal and hydraulic electricity).

Our strategy is to consolidate our position as an international benchmark in the **SAFETY OF INDUSTRIAL PROCESSES**.



### GeorGIN, working for you

At every step of your developments, our team is at your side to:

- offer information and advice on the selection of hardware,
- provide commercial support through our technical expertise,
- perform made-to-measure studies of even the most specific applications,
- provide technical assistance with the installation of our devices and systems,
- regularly maintain your GeorGIN instruments, thanks to our responsive customer service.

p.2-5

PRESENTATION

p.6



Pressure switches

p.11



Temperature switches

p.12



SPECIFIC ENVIRONMENTS

CONTROL - SECURITY

p.14



Pressure transmitters

p.16



Pressure transmitters

p.20



Temperature sensors

p.26-29



Temperature transmitters

p.30-35



Pressure gauges  
Temperature gauges

MEASUREMENT

p.36-39



Pipework and manifolds

ACCESSORIES

p.40



Zener barriers

p.42



Trip amplifier

p.44



IS interfaces

p.46



IS displays

INTRINSIC SAFETY

p.48



Signal conditioners

p.50



Conventional displays

SIGNAL CONDITIONING

p.56-55

CUSTOMERS / CERTIFICATIONS

In pictures



Since it was founded, GEORGIN has built a tradition for uncompromising quality in all its products. A combination of technical excellence and responsiveness to the needs of industry enable innovations that make a difference.







Employees who perform and listen carefully in a human-sized company.



A central geographical location 5 km from Paris and 13 km from Orly airport.

A global presence through 3 subsidiaries and a network of over 40 partners.

Products made to measure in France with individual inspection and testing of every product.

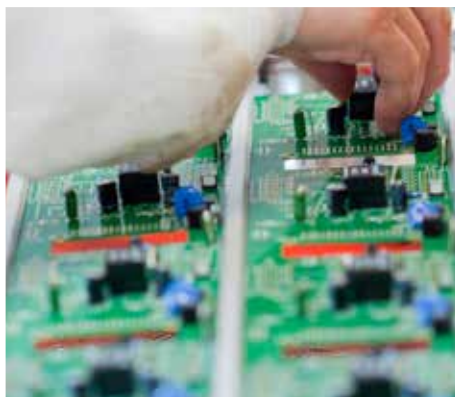

## Pressure switches

Pressure is applied to the sensing element ES. Its position then changes, acting on the flexible arm LP. The force produced in this way is balanced by the spring RG, adjusting the set point. As the set point is approached, the change in force disturbs the balance LP, acting on the switch CT.

The action of a second spring RE, acting on the flexible arm LP, increases the gap of the switch(es). The force produced by the dead band spring can be adjusted. For differential functions, it offsets the two switches.

A sensing element is closer to the process.

Bellows-actuated technology offers high repeatability. It is recommended for stable processes, not subject to pulses or pressure surges.

Diaphragm-actuated technology meets the constraints of processes involving pulsating phenomena or subject to pressure surges, and is suited to controlling low or very low pressures.

The 316L stainless steel Bourdon tube is used to control very high pressures of up to 1,000 bar.

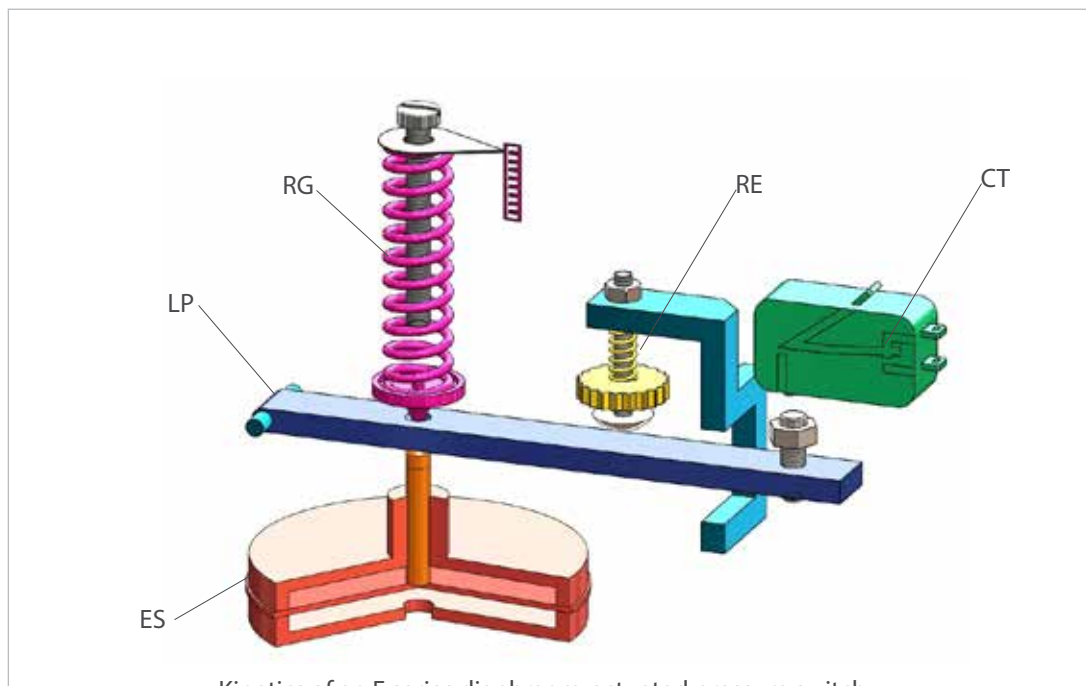

Kinetics of an F series diaphragm-actuated pressure switch



Gas or dust areas



Explosion-proof housing



Polyester housing



Stainless steel housing



Broad range of microswitches

PED category IV



ASSOCIATED PRODUCTS

Dismountable diaphragm seal to screw  
S771 - S631 - S641 - S651 series



Snubber  
A3100



Siphons  
A3000 / A3010 series



## Pressure switches

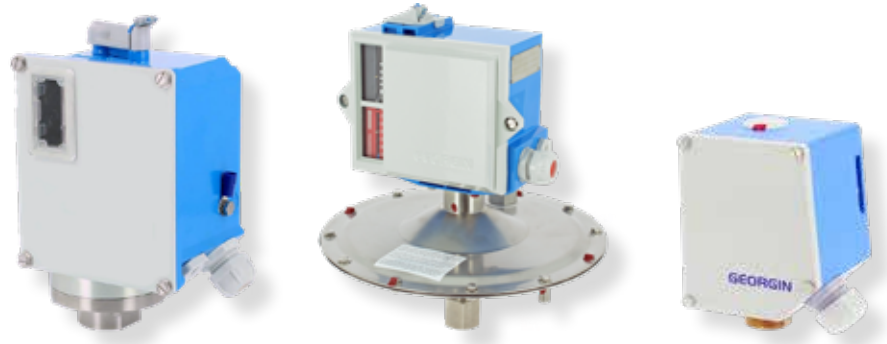

	F SERIES	P SERIES	G SERIES
Type of construction	Absolute, relative and differential pressure		
Housing	Zamak (standard) with epoxy painted Explosion-proof Polyester Stainless steel	Zamak (standard) Explosion-proof with epoxy painted	Glass fibre-reinforced polyarylamide
Protection index	IP56 to IP66 (standard) IP68 (option)	IP56 to IP66 (standard)	IP66
Electrical output	One or two microswitches		
Breaking power	1-100 mA / 4-30 V DC for gold plated contacts and up to 10 A / 240 V AC		
Pneumatic output	One or two NO or NC cells	One NO or NC cell	-
Range	0.005 to 6 bar absolute -1 to 800 bar relative 0 to 100 bar differential	0 to 3 bar absolute -1 to 800 bar relative 0.002 to 90 bar differential	-1 to 100 bar relative
Accuracy	±1% of the measurement range, higher than ±1% for certain special products		
Sensing element	Bronze or stainless steel bellows Ethylene-propylene, Viton or Perbunan diaphragm Stainless steel Bourdon tube		
Process connection	1/2"GM, 1/2"NPTM, 1/4"GM, 1/4"GF, 1/4"NPTM, 1/4"NPTF Assembly (capillary) diaphragm seal or standardised flange		
Electrical connection	Internal terminal block DIN43650 connector Others on demand		
Operating temperature limits	-40°C to +150°C, depending on the sensing element		
Ambient temperature	-20 to 70°C (standard)	-20 to 60°C (standard)	-20 to 70°C

CERTIFICATIONS AND QUALIFICATIONS			
ATEX certifications	II 1 GD Ex ia IIC T6 - Ex iaD 20 II 2 GD Ex de IIC T6 - Ex tD A21 II 2 GD Ex d IIC T6 - Ex tD A21		II 1 GD Ex ia IIC T6 - Ex iaD 20
SIL capability	SIL 2 (or 3)	SIL 2 (or 3)	SIL 2 (or 3)
EAC qualification	✓	✓	-
PED category IV	✓		-



	U SERIES	AIRGAZ SERIES
Type of construction	Relative pressure	Relative or differential pressure
Housing	Glass fibre-reinforced polyarylamide	Steel with epoxy painted
Protection index	IP65	IP20 or IP55
Electrical output	One microswitch	One or two microswitches
Breaking power	1-100 mA / 4-30 V DC for gold plated contacts and up to 10 A / 240 V AC	
Pneumatic output	-	-
Range	-1 to 40 bar relative	-100 to 1,100 bar relative 0 to 1,100 bar differential
Accuracy	±1% of the measurement range, higher than ±1% for certain special products	
Sensing element	Ethylene-propylene, Viton or Perbunan diaphragm	
Process connection	1/2"GM	
Electrical connection	Internal terminal block	Internal terminal block
Operating temperature limits	-40°C to +150°C, depending on the sensing element	
Ambient temperature	-20 to 60°C	

#### CERTIFICATIONS AND QUALIFICATIONS

ATEX certifications	-	II 1 GD Ex ia IIC T6 - Ex iaD 20
SIL capability		
EAC qualification		-
PED category IV		-



## Temperature switches

The temperature is measured by a direct bulb or differentially by a capillary.

According to the so-called vapour pressure law, the temperature is converted into pressure in the bulb and into force by metal bellows. The variation in position acts on the flexible arm LP. The force produced in this way is balanced by the spring RG, adjusting the set point. As the set point is approached, the change in force disturbs the balance of the flexible arm LP, acting on the contact. The action of a second spring RE, acting on the flexible arm LP, increases the gap of the switch(es). The force produced by the dead band spring can be adjusted. For differential functions, it offsets the two switches.

This technological choice produces short response times and measurement that is insensitive to the ambient temperature around the device.

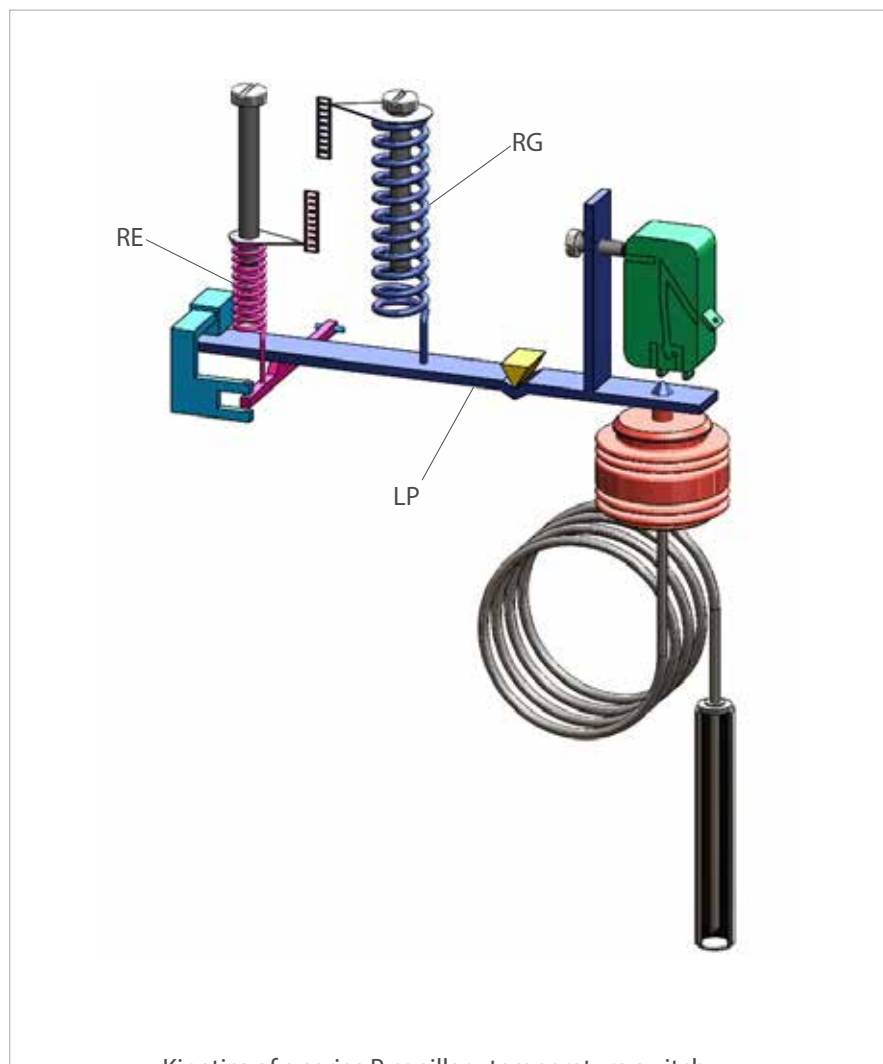

Kinetics of a series P capillary temperature switch



	F SERIES	P SERIES	U SERIES
Type of construction		Direct bulb Capillary Ambient	
Housing	Zamak (standard) Explosion-proof Polyester Stainless steel	Zamak (standard) Explosion-proof	Glass fibre-reinforced polyarylamide
Protection index	IP66	IP66	IP65
Electrical output	One or two microswitches		One microswitch
Breaking power	1-100 mA / 4-30 V DC for gold plated contacts and up to 10 A / 240 V AC		
Pneumatic output	One or two NO or NC cells	One NO or NC cell	-
Scale	-90 to 380°C	-50 to 600°C	-20 to 250°C
Accuracy	±1% of the measurement range, higher than ±1% for certain special products		
Process connection	Direct or on thermowell		
Electrical connection	Internal terminal block DIN43650 connector Others on demand		
Ambient temperature	-20 to +70°C standard	-20 to 60°C standard	

CERTIFICATIONS AND QUALIFICATIONS

ATEX certifications	II 1 GD Ex ia IIC T6 - Ex iaD 20 II 1 2 GD Ex de IIC T6 - Ex tD A21 II 1 2 GD Ex d IIC T6 - Ex tD A21		-
SIL capability	SIL 2 (or3)	SIL 2 (or3)	
EAC qualification	✓	✓	-
PED category IV	✓		-

# Pressure switches and temperature switches

Georgin has been developing pressure switches and temperature switches adapted to the most advanced process conditions for more than 30 years.

Our products meet our customers' needs and standards and the specifics of their environments.

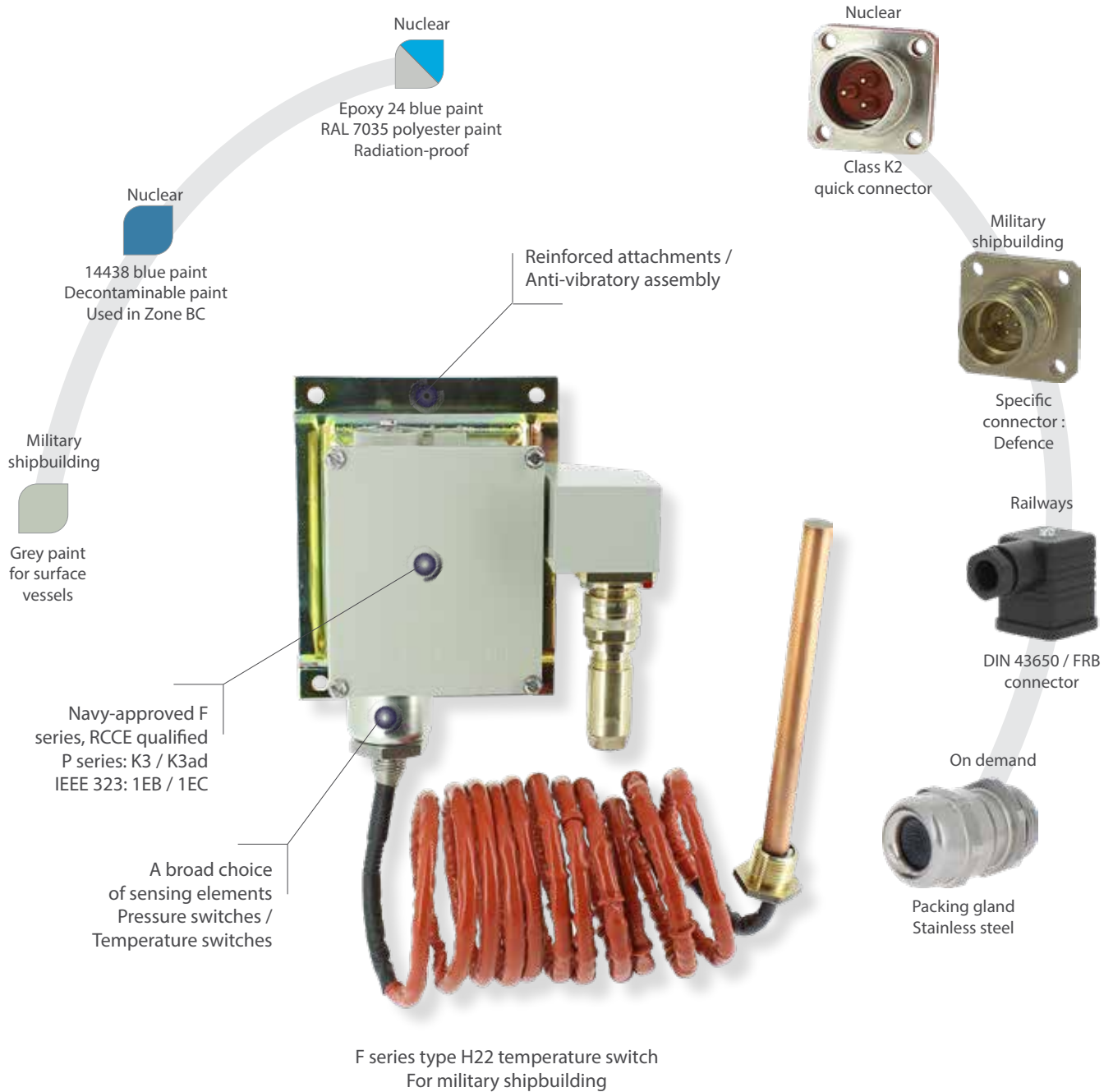



### Energy

Thanks to its broad range of technically advanced products, GEORGIN has become durably established in the energy sector.

Its expertise, certifications (HAF604) and qualifications (K3 and K3-ad) have enabled Georjin to grow in line with the development of nuclear energy. Based on its customers' faith in the company, Georjin can offer genuinely durable solutions.



### Railways

GEORGIN has collaborated with manufacturers to adapt its products to the demands and requirements of rolling stock (compact, high resistance to vibrations).



### Military shipbuilding

GEORGIN equipment meets the demanding environmental requirements of surface ships, SNA and SNLE from military fleets.

As a specialist in the military sector, GEORGIN commits to and maintains its supplies throughout the life of the installations it equips.

Photo: Pascal Subtil

## Pressure transmitters

Measuring pressure consists of converting the force applied by a fluid into a usable unit of measurement. GeorGIN offers a broad range of remote surveillance transmitters based on piezo-resistive sensors. The pressure applies stress to the sensor, creating a measurable variation in the resistance.

Various types of supports can be considered :

The TR and GR type pressure transmitters are equipped with a thick-film ceramic sensor with a Wheatstone bridge. These sensors offer a dry cell with no filler liquid and constitute an economical solution for a multitude of applications across industry.

The SR<sup>2</sup> is also available with stainless steel parts in contact with the fluid. The piezo-resistive sensor is immersed in a hydraulic liquid. The deformation of the diaphragm by the external pressure causes the hydraulic pressure of the liquid around the piezo-resistive sensor to vary. This measurement method is particularly well suited to the detection of low pressure and can withstand high overload factors.

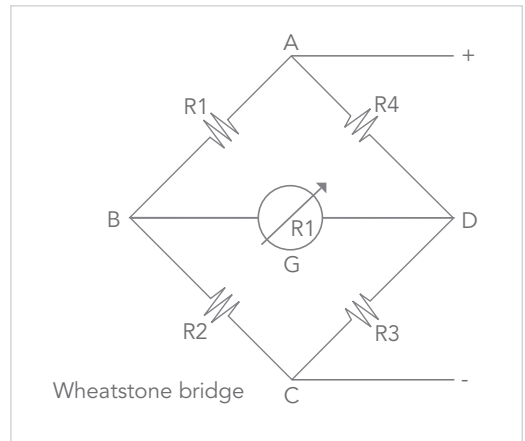





	TR/TA SERIES	GR/GA SERIES	SR² SERIES OEM APPLICATION
Type of measurement	Relative pressure (TR) Absolute pressure (TA)	Relative pressure (GR) Absolute pressure (GA)	Relative pressure
Sensor	Ceramic cell		Ceramic cell (SR1) Piezo-resistive chip (SR2)
Measurement range	-1 to 400 bar 0 to 25 bar absolute	-1 to 250 bar 0 to 25 bar absolute	-1 to 600 bar
Power supply	12 to 28 V DC	10 to 30 V DC	8 to 30 V
Accuracy	≤ 0.2%	≤ 0.5%	≤ 1%
Output signal	4...20 mA		4...20 mA 0...5 V 0...10 V
Electrical connection	DIN43650 connector Output by cable Output by cable gland	DIN43650 connector Output by cable M12 connector	DIN43650 connector M12 connector
Housing	316 stainless steel		
Protection index	IP65 (DIN43650 connector output) IP66 and IP68 (cable output)	IP65 (DIN43650 connector output) IP67 (cable output)	IP65
Process connection	1/2"GM, 1/2"NPTM, 1/4"GM, 1/4"NPTM		
Fluid temperature	-20 to 70°C	-30 to 80°C	-25 to 85°C
Ambient temperature	-20 to 70°C*	-30 to 80°C*	-25 to 85°C
OPTIONS			
Process connection	Flush stainless steel connection (1/2"GM) Flush ceramic cell (1"GM or CLAMP)	-	-
Other options	Oxygen degreasing Rangeability	Oxygen degreasing	-

\*Excluding ATEX certified products

CERTIFICATIONS AND QUALIFICATIONS		
ATEX certifications	II 1 G Ex ia IIC T6 ou T5 Ga II 1 D Ex ia IIIC T80°C ou T95°C Da	-
SIL capability	SIL 2	-
EAC qualification	✓	-

## Process transmitters

Measuring pressure consists of converting the force applied by a fluid into a usable unit of measurement. The transmitters in the ProcessX family use capacitive technology.

The effect of the pressure deforms a silicon diaphragm. The plates of the capacitor detect this movement and convert the difference in capacitance between the detector diaphragm and the plates of the capacitor into a 4-20 mA signal. These sensors benefit from a micro-sensor developed from a silicon chip that floats in the throat of the cell. This minimises errors due to the variations in temperature, static pressure and over-pressure that are common in process industry.

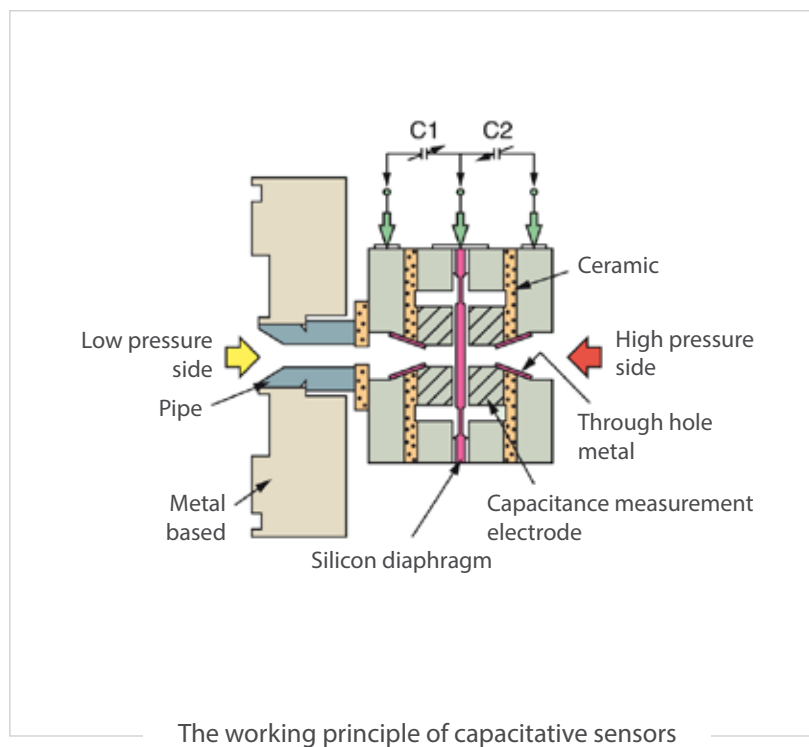

**IECEX**  Gas or dust areas

Built of aluminium alloy with a polyester coating or a stainless steel housing

Accuracy up to 0.04% and a stability of  $\pm 0.1\%$  of the maximum scale for 10 years

**SIL CAPABILITY**

**HART**  WE'VE GOT ABILITY

ASSOCIATED PRODUCTS

Flange-mounted manifolds with 2, 3 or 5 valves  
A3300 series



Diaphragm seal with standardised flange  
S680 - S660 series



## Process transmitters



	FKP	FKH	FKC
Type of measurement	Relative pressure	Absolute pressure	Differential pressure
Measurement range	Up to 100 bar	Up to 30 bar absolute	Up to 200 bar at a static pressure of 300 bar
Accuracy	0.1%	0.2%	0.065%
Storability	16:1		100:1
Output signal	4...20 mA + HART®		
Power supply	10.5 to 45 V DC 10.5 to 32 V DC for ATEX		
Electrical connection	M20 x 1.5, Pg13.5, 1/2" NPTF		
Protection index	IP66 - IP67		
Process connection	1/2" NPTF as standard	1/2" NPTF as standard	Flange-mounted type - 1/4" NPTF as per DIN 19213
Materials in contact with fluid	316 stainless steel		
OPTIONS			
Housing	Housing with display on front Stainless steel housing		
Display	Analogue or digital		
Materials in contact with fluid	-		Hastelloy-C or PVDF

CERTIFICATIONS AND QUALIFICATIONS	
ATEX and IECEx certifications	II 1 G (for ATEX) Ex ia IIC T4 / T5 Ga II 1 D (for ATEX) Ex ia IIIC T100°C / T135°C Da Ex ia IIC T5 / T6 Gb
SIL capability	SIL 2



	FKG	FKA	FKE
Type of measurement	Relative pressure	Absolute pressure	Level
Measurement range	Up to 500 bar	Up to 100 bar absolute	Up to 300 mH2O
Accuracy	0.065%	0.2%	0.165%
Storability	100:1		
Output signal	4...20 mA + HART®		
Power supply	10.5 to 45 V DC 10.5 to 32 V DC for ATEX		
Electrical connection	M20 x 1.5 , Pg13.5, 1/2" NPTF		
Protection index	IP66 - IP67		
Process connection	Flange-mounted type - 1/4" NPTF, as per DIN 19213		On standardised flange(s) in rigid or capillary assembly
Materials in contact with fluid	316 stainless steel		

**OPTIONS**

Housing	Housing with display on front Stainless steel housing
Display	Analogue or digital
Materials in contact with fluid	Hastelloy-C or PVDF

**CERTIFICATIONS AND QUALIFICATIONS**

ATEX and IECEx certifications	II 1 G (for ATEX) Ex ia IIC T4 / T5 Ga II 1 D (for ATEX) Ex ia IIIC T100°C / T135°C Da Ex ia IIC T5 / T6 Gb
SIL capability	SIL 2



## Temperature probes

### ■ Resistance probes

Resistance temperature probes use the variation in resistance according to the temperature. The RTD100 sensor is a 100 Ohms platinum resistor at 0°C. The measurement current must not exceed 1 mA in order to reduce the risk of the probe self-heating. The three-wire RTD100 is the most widely used option. It is economical and precise. The measurement principle does away with some of the errors caused by the line resistance. The resistance of the three lines (R1, R2 and R3) must be identical.  $R_{RTD100} = [V1 - (2 \times V2)] / I$

In the three-wire configuration, the recommended maximum length of the connecting wires is 500 metres. To achieve greater accuracy and limit errors, the use of a TiXo or Tia temperature converter will make it much easier to use the signal. Other configurations, and in particular two- and four-wire, also exist.

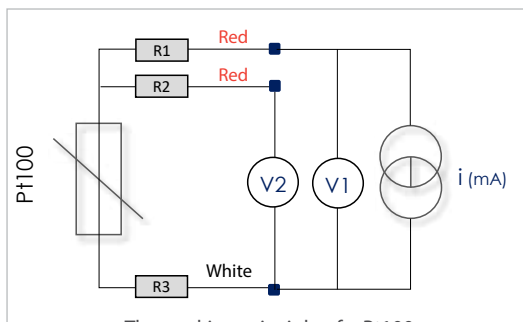

The working principle of a Pt100

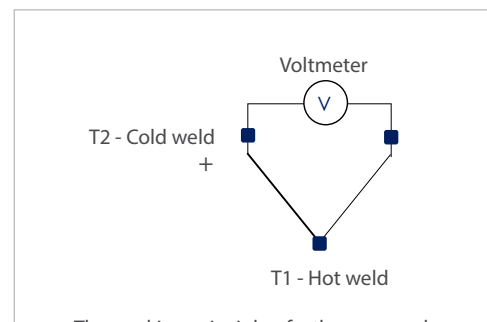

The working principle of a thermocouple

### ■ Thermocouple probes

Thermocouples offer very short response time, and they are compact and robust. Two different types of metals are connected by two junctions at the temperatures T1 and T2. Due to the Seebeck effect, the thermocouple generates a difference of potential that depends on the difference between the temperatures at the junctions. There are several types of thermocouples, according to the temperature range. For example, K thermocouples are made of nickel-chrome / alumel alloy and cover a temperature range from -200°C to 1,100°C. The electrical signals returned by these probes are non-linear and are in the range of the millivolt. Therefore, the quality of measurement depends mainly on the converter used. GEORGIN recommends TiXo 2 or 3, which allows for linearisation and galvanic insulation that protects the signal against any electromagnetic interference.

"SSC" quick coupling  
 "Speed Sensor Coupling"



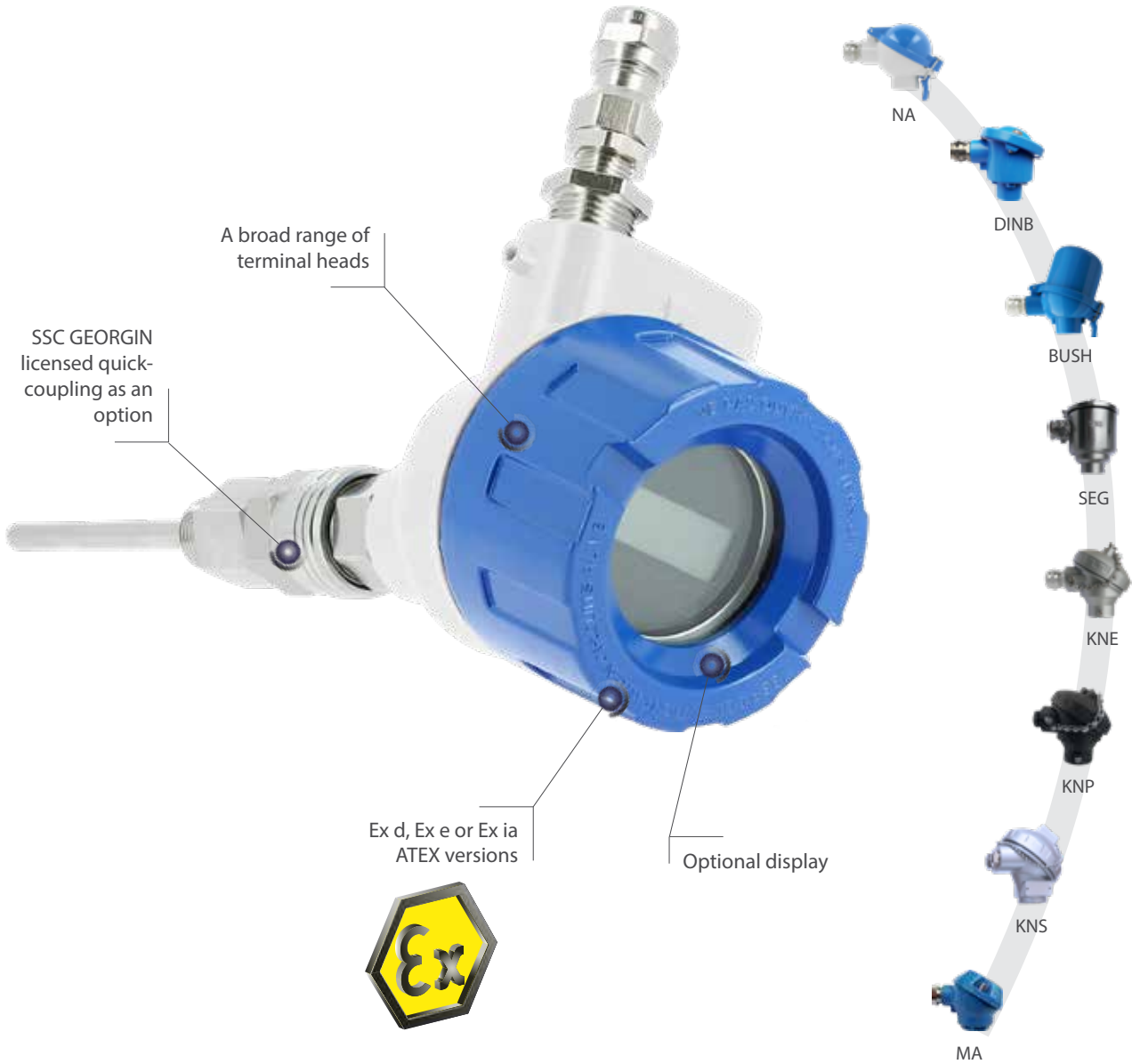

ASSOCIATED PRODUCTS

Displays  
GSI 40 / 48



Temperature transmitters  
TiXo & Tia



Converters  
and trip amplifier



## Temperature probes



	S*VF	S*VI	S*DF	S*DI
Process installation	Screw-on		Screw-on with extension	
Type of head	NA, DAN, DAN-V, B, KNA, MA, SEG, BUSH, BBK, NORYL, ABS, DIN B, BUSH glazed + 12 mm four-digital LCD display, DAN, ADF (*=4), Glazed ADF + display (*=4)			
Installation of the measuring element	Fixed	Interchangeable	Fixed	Interchangeable
Type of measuring element	Resistive : RTD100, RTD1000, Ni100, Ni1000, etc. Thermocouple elements : Tc K (-180 +1372°C); Tc J (-100 +1200°C); Tc E (-100 +1000°C); Tc L (-100 +900°C)...			
Installation	RTD100 : 2, 3 or 4 wires, class A, B, 1/3DIN, 1/5DIN, 1/10DIN, etc. Thermocouple : simple, duplex, double, etc., class 1 or 2, etc.			
Working temperature	-50°C /+400°C ; -200°C /+600°C ; -200°C /+1200°C, etc.			
Sleeve material	304 stainless steel, 316L, 600 inconel, other on demand			
Process connection	1/2" - 3/8" - 1/4" - 3/4 - 1" GM or NPTM or SSC (GEORGIN licence)			
Diameters	Ø 3, 4, 5, 6, 8, 9 mm	Ø 6, 8, 9, 10 mm	Ø 3, 4, 5, 6, 8 mm	Ø 6, 8, 9, 10 mm
Length	All lengths			
Extension	None		50, 100, 200 mm	
Packing glands	M20 x 1.5 nickel-plated brass, M12 connector, SAIB 251-103-401 socket, ATEX Exd ADE1F 1/2"NPT (*=4), ATEX Ex d ADE4F 1/2"NPT (*=4), ATEX Ex i M20 x 1.5 blue (*=5)			
Converters	TiXo1A, 2A or 3A (* = 1 or 4); TiXo1B, 2B or 3B (* = 5)			
	Special designs on demand			
<b>OPTIONS</b>	1, 2, 3, 5-point calibration certificate Certificate 3.1B / Stress calculation / NACE certificate			
<b>ATEX CERTIFICATIONS</b>	II 2 G Ex e II T6 (S3) II 2 G Ex d IIC T6 (S4) II 1 G Ex ia IIC T4...T6 (S5)			

\* = 1(standard), 3(Ex e), 4(Ex d), 5(Ex i)



	S*LF	S*LI	S*MI	S*UI
Process installation	Flush (no coupling)		Screw-on with sleeve	Screw-on with sleeve and union coupling
Type of head	NA, DAN, DAN-V, B, KNA, MA, SEG, BUSH, BBK, NORYL, ABS, DIN B, BUSH glazed + 12 mm four-digital LCD display, DAN, ADF (*=4), Glazed ADF + display (*=4)			
Installation of the measuring element	Fixed	Interchangeable		
Type of measuring element	Resistive : RTD100, RTD1000, Ni100, Ni1000, etc. Thermocouple elements : Tc K (-180 +1372°C); Tc J (-100 + 1200°C); Tc E (-100 +1000°C); Tc L (-100 +900°C)...			
Installation	RTD100 : 2, 3 or 4 wires, class A, B, 1/3DIN, 1/5DIN, 1/10DIN, etc. Thermocouple: simple, duplex, double, etc., class 1 or 2, etc.			
Working temperature	-50°C /+400°C ; -200°C /+600°C ; -200°C /+1200°C, etc.			
Sleeve material	304 stainless steel, 316L, 600 inconel, other on demand			
Process connection	-		1/2" GM or NPTM	
Diameters	Ø 3, 4, 5, 6, 8 mm	Ø 6, 8, 9, 10 mm		Ø 6, 8 mm
Length	All lengths			
Extension	None		100, 150, 200 mm steel or 316L stainless steel	
Cable glands	M20 x 1.5 nickel-plated brass, M12 connector, SAIB 251-103-401 socket, ATEX Ex d ADE1F 1/2"NPT (*=4), ATEX Ex d ADE4F 1/2"NPT (*=4), ATEX Ex i M20 x 1.5 blue (*=5)			
Converters	TiXo1A, 2A or 3A (* = 1 or 4); TiXo1B, 2B or 3B (* = 5)			
	Special designs on demand			
OPTIONS	1, 2, 3, 5-point calibration certificate Certificate 3.1B / Stress calculation / NACE certificate			
ATEX CERTIFICATIONS	II 2 G Ex e II T6 (S3) II 2 G Ex d IIC T6 (S4) II 1 G Ex ia IIC T4...T6 (S5)			

\* = 1(standard), 3(Ex e), 4(Ex d), 5(Ex i)

## Temperature probes



	<b>S*AA</b>
Type	Display ambient conditions



	<b>S*AI</b>
Type	Industrial ambient conditions



	<b>S*AE</b>
Type	Economic ambient conditions



	<b>S*CF</b>
Type	Fixed-element clamp



	<b>S*PB</b>
Type	Pyrometric with clamp



	<b>S*PL</b>
Type	Pyrometric flush



	<b>S*MU</b>
Type	WITH multi-point with flange



	<b>S*BA</b>
Type	Bayonet probe



	<b>S*CO</b>
Type	Eyelet contact



	<b>S*CC</b>
Type	Collar contact



	<b>S*CV</b>
Type	Aluminium V-shaped contact with head



	<b>S*VA</b>
Type	V-shaped contact aluminium

\* = 1 (standard), 4 (Ex d), 5 (Ex i), depending on the model





	S*CI	S*SF	S*SI	S*PD	S*PC
Type	Interchangeable-element clamp	Fixed-element SMS	Interchangeable-element SMS	Straight tap	Angle tap



	S*PA	S*VT	S*VD	S*VE	S*VM
Type	Level probe	Screw-on with 4/20 mA transmitter and DIN43650 connector	Screw-on with DIN43650 connector	Screw-on with HART transmitter and M12 connector	Screw-on with M12 connector



	S*CM	S*FC	S*LC	S*VC	S*CM
Type	Magnetic contact	Tank base	Flush with cable	Screw-on onto cable	Compensated miniature connector

\* = 1(standard), 4(Ex d), 5(Ex i), depending on the model

## Temperature transmitters

The TiXo family of temperature transmitters make it easier to use RTD100 or thermocouple sensors and can be integrated into the probe head.

Their main function consists of converting temperature signals into a proportional 4/20 mA signal capable of covering long distances without loss.

The TiXo converters can also diagnose the operational status of the sensor, while changing the signal in the event of a cut.

These devices are designed to be installed close to the process in difficult environments, while guaranteeing a high safety level.

The TiXo has a SIL 2 capacity and can be installed in zone 0 (ATEX II 1 G) or dust zone 20 in its intrinsic safety version B Ex ia.

Installation in zone 2 can be made easier thanks to Ex nA certification.

The easy-to-use programming with ProgressXmanager in the Windows environment, or using FDT/DTM technology, offers a broad range of solutions to configure the type of input, the scale and unit, or online measurement readings or output simulations.

The most advanced version of TiXo3 uses the latest HART 7 communications protocol.

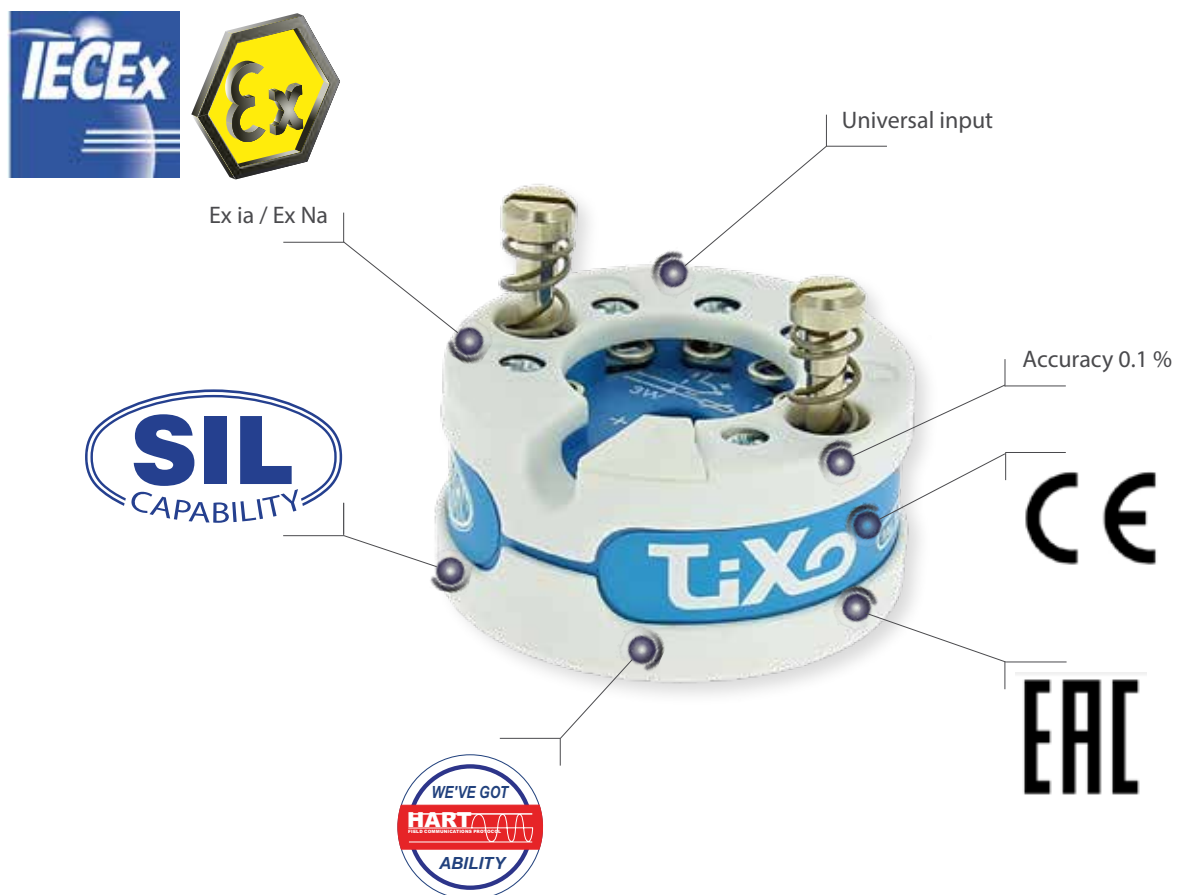



		TiXo1 A / B	TiXo2 A / B	TiXo3 A / B
Installation		Type B head or higher dimension		
Input		RTD100 2 or 3 wires	Resistive sensors	
			Thermocouples	
Output		4...20 mA		4...20 mA
				With HART® protocol
Power supply	Standard version A	8 to 30 V DC	10 to 30 V DC	
	ATEX version B	8 to 28 V DC	10 to 28 V DC	
Insulation		-	1,500 V AC	
Response time		< 2 seconds (t63 < 0.8 seconds)		
Accuracy		< 0.1% FS or < basic accuracy		
Programming		ProgressXmanager		
		FDT-DTM		
		TiXlink 1		HART® modem
OPTIONS		Factory configuration of converters REGTX. Attachment for DIN rails ACCDIVTIX01.		

CERTIFICATIONS AND QUALIFICATIONS

ATEX certifications	Gas/Dust	Ex II 1 GD Ex ia II C	
	Gas	Ex II 3 G Ex ic IIC	Ex II 1 GD Ex iaD 20
SIL capability		SIL 2	
EAC qualification		✓	

ASSOCIATED PRODUCTS

S series head probes



I.S. Power supply



HART TiXlink 4 modem

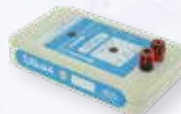

ACCDIVTIX01  
DIN attachment for TiXo



ProgressXmanager or DTM



## Temperature transmitters

The Tia family of temperature transmitters make it easier to use RTD100 or thermocouple sensors and can be integrated into a cabinet or a housing mounted on a DIN rail.

Their main function consists of converting temperature signals into a proportional 4/20 mA signal capable of covering long distances without loss.

The Tia converters can also diagnose the operational status of the sensor, while changing the signal in the event of a cut.

These devices are designed to be installed close to the process in difficult environments, while guaranteeing a high safety level.

The Tia has a SIL 2 capability and can be installed in zone 0 (ATEX II 1 G) or dust zone 20 in its intrinsic safety version B Ex ia.

Installation in zone 2 can be made easier thanks to Ex nA certification.

The easy-to-use programming with ProgressXmanager in the Windows environment offers a simple solution to configure the type of input, the scale and unit, or online measurement readings or output simulations.

The most advanced version of Tia uses the latest HART 7 communications protocol.





		Tia2 A / B	Tia3 A / B
Installation		Rail DIN	
Input		Resistive sensors Thermocouples	
Output		4...20 mA	4...20 mA With HART® protocol
Power supply	Standard version A	10 to 30 V DC	
	ATEX version B	10 to 28 V DC	
Insulation		1,500 V AC	
Response time		< 2 secondes (t63 < 0,8)	
Accuracy		< 0,1% FS ou < précision de base	
Programming		ProgressXmanager FDT-DTM	
		TiXlink X 1	HART® TiXlink 5 modem
<b>OPTIONS</b>		Factory settings for REGTX converters	

CERTIFICATIONS AND QUALIFICATIONS		
ATEX certifications	Gas/Dust	Ex II 1 G Ex ia IICT6 Ga II 1 D Ex ia IICT85°C Da
	Gas	II 3 G Ex nA IIC T6 Gc
SIL capability		SIL 2
EAC qualification		✓

ASSOCIATED PRODUCTS

ATEX Mounting cabinets



I.S. Power supply



HART  
TiXlink 4 modem



TiXlink 5  
power supply cables



ProgressXmanager  
or DTM



## Pressure gauges

In addition to its pressure measurement and control solutions, GeorGIN also proposes a wide range of industrial pressure gauges.

A Bourdon tube usually forms the heart of these mechanical constructions. These tubes have an oval-shaped cross-section and are curved. The measured fluid acts on the tube. As a consequence, the tube is distorted, and this distortion is sent to the mechanical parts by a connecting rod. The needle rotates proportionally to the value of the pressure.

C-shaped tubes can be used for pressures up to 60 bar. Helical or spiral-shaped tubes are used for higher pressures.

Stainless steel diaphragms can also be used for lower pressures, processes subjected to vibrations and differential constructions. The membrane can also be lined, for example with PTFE, for reasons of compatibility with the fluid.

The pressure gauge is applied and adapted to the requirements of the process around the sensor element.

These requirements may be due to its installation (position of the process connection, assembly supports or damping liquids for vibratory processes), to site safety (safety vents as standard, optional ejector rear panels) or to environmental demands (316 stainless steel or phenolic housing, ATEX constructions, etc.).



The working principle of the GeorGIN pressure gauge





Gas or dust areas

Built of 304 or 316 stainless steel



Micrometric adjustment screw

Customisable dial

Flexible process connections

ASSOCIATED PRODUCTS

Needle valves  
A3200 series



Over pressure protector  
A3400 series



Monobloc screw-on separators  
S131 series



Pressure gauges



	M5000	M5010 OEM TYPE	M5050 OFFSHORE TYPE
Sensor	316L stainless steel manometric tube		
Measurement range	-1...0...0.6 bar to 1,000 bar	-1...0...0.6 bar to 0...1,000 bar	-1...0...0.6 bar to 1600 bar
Movement material	304 stainless steel	Brass	304 stainless steel
Standard pressure connection	1/4" (Ø 63) or 1/2" (Ø 100/150) 316L stainless steel	1/4" (Ø 63) or 1/2" (Ø 100) 316L stainless steel	1/2" 316L stainless steel
Class	1%	1.6%	0.5% (Grade 2A)
Housing	Ø 63/100/150 mm 304 stainless steel	Ø 63/100 mm 304 stainless steel	Ø 4" 1/2 Polypropylene
Window material	Securit glass	Polycarbonate	Plexiglass
Protection class	IP65		
Filling	Option	Glycerin	Option
OPTIONS			
ATEX marking	II 2 GDc T(*) IP65 T(*)	-	-
Housing	316L stainless steel	-	-
Sensing element	400 monel	-	400 monel
Electrical contact	One or two magnetic contacts	-	-
Other	External zero adjustment Class 0.5 Flange or mounting kit O2 degreasing IP66 or IP67 Customer logo Diaphragm seal mounting Stainless steel tag plate Special connection Solid front Special unit Damper screw	Dry housing Flange or mounting kit O2 degreasing Customer logo Stainless steel tag plate Special connection Special unit Damper screw	Flange or mounting kit NACE compliance O2 degreasing Customer logo Diaphragm seal mounting Stainless steel tag plate Special connection Solid front Special unit Damper screw
ATEX CERTIFICATIONS	II 2 G Ex h IIC T6...T3 Gb X II 2 D Ex h IIC T85°C...T200°C Gb	-	-



	M5100	M5200	M7000
Sensor	316L stainless steel capsule	316L diaphragm	
Measurement range	-600..0...600 mbar	-1...0...40 mbar to 0...16 bar	0...0.06 bar - 0...40 bar Static pressure of 100 bar
Movement material	304 stainless steel		
Standard pressure connection	1/2" 316L stainless steel		2x 1/4" vertical NPTF 316L stainless steel
Class	1.6		
Housing	Ø 100 / 150 mm 304 stainless steel		
Window material	Securit glass		
Protection class	IP54		
Filling	Option		
OPTIONS			
ATEX marking	-	II 2 GDc T(*) IP65 T(*)	
Housing	316L stainless steel		
Sensing element	-	Monel, PTFE, Hastelloy, etc. Direct connection to flange	Monel, Hastelloy, etc.
Electrical contact	-	One or two magnetic contacts	
Other	Flange or mounting kit O2 degreasing Customer logo Stainless steel tag plate Special connection Solid front Special unit	Flange or mounting kit O2 degreasing IP67 Customer logo Stainless steel tag plate Special connection Special unit	O2 degreasing U-Clamp IP67 Customer logo Capillary-diaphragm seal installation Stainless steel tag plate Static pressure up to 250 bar Special connection Solid front Special unit
ATEX CERTIFICATIONS	-	III 2 G Ex h IIC T6...T5 Gb X II 2 D Ex h IIC T85°C...T100°C Gb X	

## Thermometers

Georgin's range of thermometers varies according to two main kind of measurement: bimetal and gas expansion.

- The bimetal is a strip of laminar and coiled metal blades with different expansion coefficients. The strip twists in proportion to the variations in temperature and causes the shaft of the thermometer needle to turn.
- A gas expansion product uses a sensor assembly full of liquid that is hermetically closed and pressurised. It is made up of a bulb, a capillary and a Bourdon tube. The movement of the extremity of the tube causes the shaft of the thermometer needle to turn. This design can be used to separate the point of reading from the point of measurement.

In addition to the different types of sensor, these thermometers can also be adapted to the process requirements (direct bulb or remote, housing with a collar or calliper for assembly on a 2" tube, etc.) or environmental requirements (316L stainless steel housing, ATEX certified products, etc.).

All the thermometers can be installed on the process in a thermowell.



Deformation of the bimetal in a type T7000 thermometer



	T7000 SERIES	T7100 SERIES
Sensor	Coiled bimetal element	Gas expansion
Type of stem	Direct Vertical, rear or adjustable	Direct or capillary Vertical or rear
Stem diameter	6 or 8 mm	
Measurement range	-50 to 400°C	-200 to 600°C
Movement material	304 stainless steel	
Process connection	1/2" turning-sliding or 1/2" fixed	
Class	1	
Housing	304 stainless steel Ø 100 / 150 mm	
Glass material	Securit glass	
Protection class	IP65	
OPTIONS		
Housing	IP66 or IP67 or hermetic	
Filling	Glycerin or silicone as an option	
Stem diameter	6.35 / 9.5 / 10 or 12 mm	
Installation	Flange or mounting kit	
Electrical contact	-	One or two magnetic contacts
Other	External zero adjustment 1/4", 3/4", 3/8", etc., special connection Customer logo Special unit Stainless steel tag plate	External zero adjustment Capillary up to 25 m 304 or 316 stainless steel sheath 1/4", 3/4", 3/8", etc., special connection Customer logo Special unit Stainless steel tag plate

ATEX CERTIFICATIONS

II 2 G Ex h IIC T6...T1 Gb X  
II 2 D Ex h IIC T85°C...T450°C Gb X)

ASSOCIATED PRODUCTS

Thermowell  
GT - GM



Thermally  
conductive pastes  
Rhodorsil type  
ACCDIVGNPC7

## Pipework

The analysis of the process specifications often results in the proposal of associated products.

It is important to take all the over-pressures and impulses that could damage the product into consideration. Limiters, dampers and capillaries are accessories that can help to reduce these phenomena.

Excessive temperatures can also harm the proper working order of the associated equipment. In this case, a capillary (cooling of 50 to 70°C/meter, depending on the conditions) or a cooling tower (cooling of 20 to 30°C, depending on the conditions) is used. Siphons are generally used on vapour circuits.

The angled or bent part of the siphon allows for the formation of condensate that protects the measuring instrument. It is also possible to put a coolant inside the bend before it is put into operation.

With superheated water, the siphon is only used to lower the temperature. Siphons can also provide protection against pressure surges. The design of this product is subject to the standard DIN16282.

Regarding the temperature measurement, the use of thermowell facilitates maintenance, calibration and the replacement of sensors, without interrupting the process.

Different types of process connections can be used : screw-on, welded or with flange.

There are two types of build, depending on the application: the sheaths can be mechanically welded for standard applications without any important stress, or drilled for more severe process conditions, such as high temperatures, pressures or flow rates.

They can be machined in different materials: AISI316L, AISI304L, AISI446, AISI310, 316TI, 321, Incoloy, alloy, Hastelloy, Inconel, nickel, Monel, PVC, PTFE, etc.

For certain applications in corrosive environments, the thermowells must have a Teflon, PTFE, HALAR, tantalum or stellite type coating for abrasive applications.

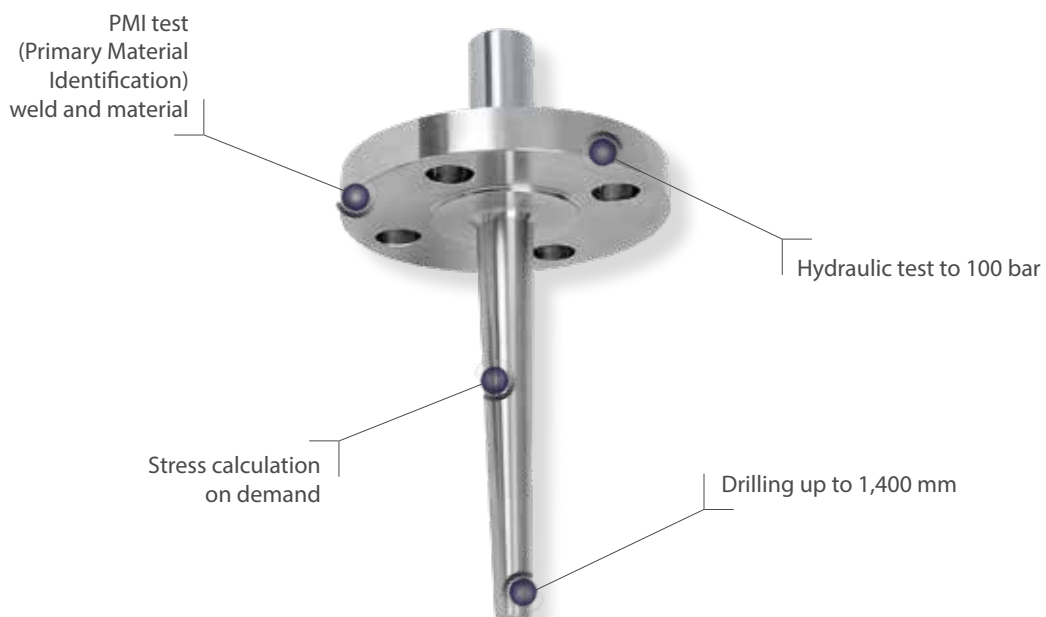





<b>A3200</b>	<b>A3200</b>	<b>A3200</b>	<b>A3300-1</b>
DIN16270 valves	DIN16271 valves	DIN16272 valves	One-valve manifolds



<b>A3400</b>	<b>A3100</b>	<b>A3030</b>	<b>A3020</b>
Pressure limiters	Dampers	Capillaries	Cooling towers



<b>A3000</b>	<b>A3000</b>	<b>A3010</b>
Gauge siphons	U-shaped siphons	Cooling towers



<b>A3700</b>	<b>A3500</b>		<b>CFI</b>
Rotating connections	Welded connections	Adapter connections	Turning-sliding connections



<b>GM</b>	<b>GT</b>		<b>ACCDIVSSC</b>
Welded thermowells	Barstock thermowells	Flanged barstock thermowells	SSC adapters "Speed Sensor Coupling"

## Manifolds

In partnership with the German family-based company AS-Schneider, Geogin markets a broad range of manifolds. You should choose your 2, 3 or 5 valve manifold according to two essential criteria:

- The design of the valve body that makes installation easier and optimises ease of use by offering ready access to the process in the maintenance phases.
- Consideration of the nature of the fluid, both in the selection of the material of the body (carbon steel, rust-proof or duplex materials, alloys, titanium, etc.) and of the material of the tap seals (PTFE as standard).

As shown below, the coloured rings identify the insulation, drain and balancing. Optional markings can be added to identify the graphite seal, a PCTFE endpiece, reinforced sealing solutions or equipment that can be used with oxygen.

The modularity of the range also allows for a broad choice of taps that meet normative requirements (emissions of volatiles), process safety requirements (OS&Y valve) or site security (anti-vandalism systems).

Every assembly is tested at 1.5 times the maximum service pressure, as per EN 12266-1.

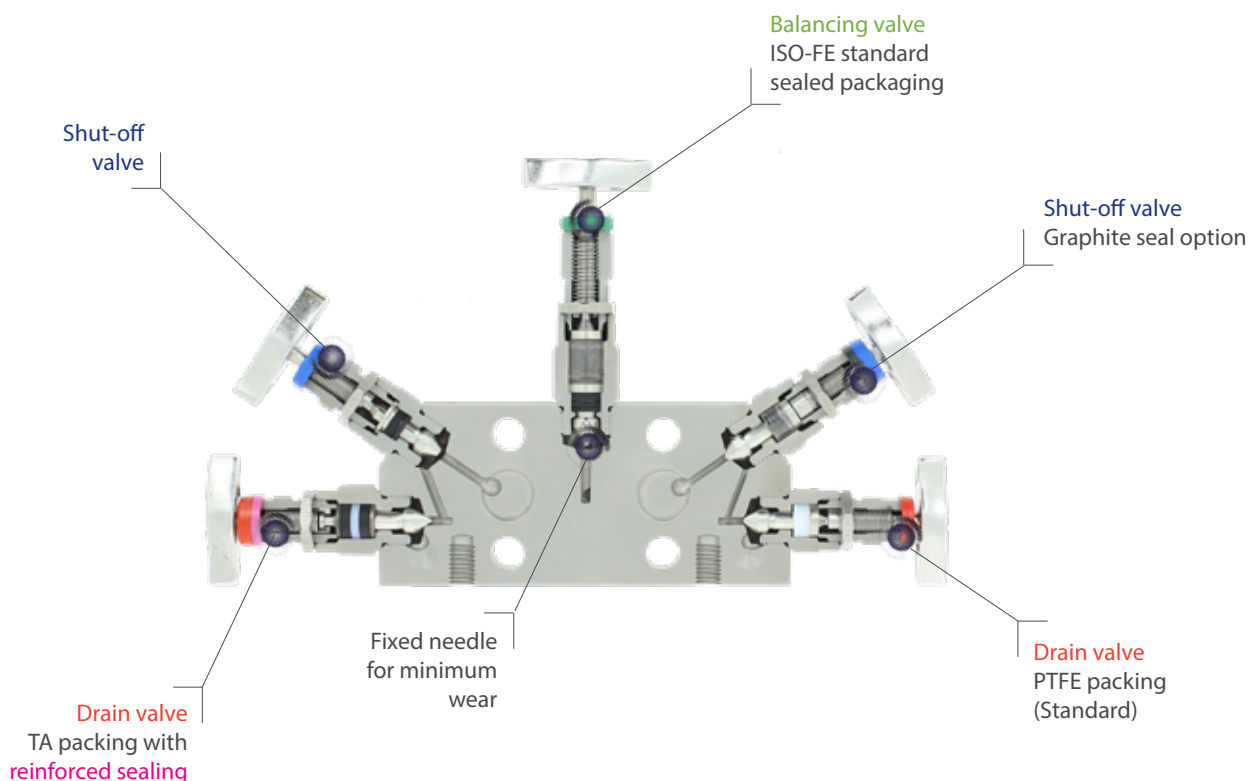



A3301-2

A3302-2

A3303-2

Manifolds for online installation



A3304-2

A3304-2

A3304-5

Manifolds for online or remote installation



A33F1-2

A33F2-3

A33F4-3

Flange-mounted manifolds

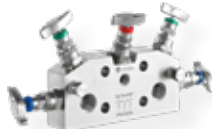

A33F2-5

A33F4-5

A33F6-5

Flange-mounted manifolds



A33P1-2

A33P1-3

A33P1-5

Traditional flange-mounted manifolds

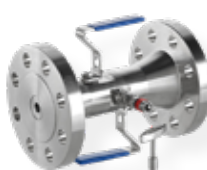

A3300-M

A3300-DBB

Process single-flange

Block with dual-isolation and drain

## Zener barriers

Zener barriers contribute to the intrinsic safety [Ex i] and are installed in safe areas. Their mission is to limit the level of energy that may appear in an electric circuit routed through a potentially explosive area, whatever the connection established upstream of the barrier.

A barrier is made up of:

- resistors that limit the current
- Zener diodes that limit the voltage
- fuses that protect the components

When a fault voltage is applied across the input terminals of the barrier, the voltage that may appear in the explosive zone is limited by a Zener diode, which is in turn protected by a fuse.

The current is limited to an acceptable value by the resistor.

They can be installed in zone 2, thanks to the Ex nA certification in an IP 54 housing.





	bzg787+	bzg(2)728+/L+	bzg789+
Application	4...20 mA transmitters I/P 4...20 mA converters		Switch
IS parameters	U <sub>o</sub> = 28 V, I <sub>o</sub> = 89.31 mA P <sub>o</sub> = 625.2 mW	U <sub>o</sub> = 27.3 V, I <sub>o</sub> = 95.79 mA P <sub>o</sub> = 653.76 mW	U <sub>o</sub> = 28 V, I <sub>o</sub> = 47.54 mA P <sub>o</sub> = 332.77 mW
Metrological parameters	U(e) = 24.90 V, I <sub>fm</sub> = 50 mA RL = 341.3 and 0.9 V+11.3Ω	U(e) = 24.90 V, I <sub>fm</sub> = 50 mA RL = 311.3Ω	U(e) = 24.90 V, I <sub>fm</sub> = 50 mA RL = 658.3 and 0.9 V+11.3Ω



	bzg715+	bzg756AC	bzg760AC
Application	12 V system power supply	RTD100 3-wire temperature	Thermocouple temperature
IS parameters	U <sub>o</sub> = 14.39 V, I <sub>o</sub> = 151.42 mA P <sub>o</sub> = 544.55 mW	Refer to the documentation	U <sub>o</sub> = 5.64 V, I <sub>o</sub> = 63.1 mA P <sub>o</sub> = 88.89 mW
Metrological parameters	U(e) = 12 V, I <sub>fm</sub> = 100 mA RL = 103.6	U(e) = 0.7 V, I <sub>fm</sub> = 50 mA RL = 26.3Ω per line	U(e) = 1.20 V, I <sub>fm</sub> = 100 mA RL = 101.2Ω
Installation	DIN rail		
OPTION	LED on front (depending on the model)		

CERTIFICATIONS AND QUALIFICATIONS

ATEX [Ex ia] gas / dust	II (1) GD [Ex ia Ga] IIC
ATEX Ex nA zone 2 gas	II 3 (1) G Ex nA [ia Ga] IIC T4 Gc
SIL capability	Up to SIL 3 (EN 61508), depending on the applications and models
EAC qualification	✓

Numerous other references and made-to-measure studies.

ASSOCIATED PRODUCTS

ATEX cabinets



Loop studies



DIN rail  
insulation kits



Ground connecting  
combs





## Signal interfaces

The galvanically insulated interface is an associated intrinsic safety item of equipment that is installed in a safe zone or in zone 2 in an IP 54 housing, thanks to the Ex nA protection mode. Its mission is to limit the level of energy that may appear in an electric circuit routed through a potentially explosive area, whatever the connection established upstream.

In addition to its energy-limiting function, it facilitates the use of signals in safe areas (e.g., relays), converts signals (e.g., 4/20 mA to 0-10V) or duplicates signals.

Other functions are also available, such as the threshold relay or powering intrinsic safety.







	UITAX	BPX100*-1*-1A	BPX100*-1*-0B
FUNCTION	Trip amplifier		
Installation	DIN rail		
Universal input	mA: 2, 3 and 4-wire transmitter (active) / Current (-2.5 to 23 mA) V: Voltage (-10 to 105 mV) mV: Thermocouple (J, K, B, R, S, E, N, W5) / Voltage (-1 to 10.5 V) Ω: Pt100 2, 3 and 4 wire / potentiometer 0 to 100%		
Number of input channels	1		
Analogue output	3.5 to 23 mA active or passive		
HART transparent	No. See AITA	Yes, as option	
Relay outputs	2 x RT or 1 SPDT	2 x SPDT (5 A 250 V 100 VA)	4 x relays (3 A 250 V 100 VA)
Power supply	Universal	98 to 255 V AC (*=E) / 21 to 53 V DC (*=2)	
Insulation	2,500 V AC 50 Hz		
Accuracy	0.1% (depending on the input)		
Programming	ProgressXmanager with USB cable	ProgressXmanager with RS232 serial connection cable	
	Type of input, scale, output (direct or inverted), thresholds (time delay, hysteresis), online measurement, output simulation, etc.		

CERTIFICATIONS AND QUALIFICATIONS

ATEX [Ex ia] gas	II (1) G/D [Ex ia] IIC	
ATEX [Ex ia] dust	Ex nA nC IIC T4 Gc	
SIL capability	SIL 2	SIL 2, depending on the applications
EAC qualification	-	✓

ASSOCIATED PRODUCTS

ATEX cabinets



Loop studies



Rear power supply connectors



Standard USB cable



Software ProgressXmanager



I.S. interfaces



Analog input ←	BXL/M/N/T (I) ▲●	BPX100*-1*-10 ▲●	BXN R,RV,C,P,T(I)
FUNCTION	Transmitter power supply	Universal input	Converter
Input signal (zone)	Active or passive (choice on the terminals) 4...20 mA	Universal: 4...20 mA, mA/V, mV, RTD, TC, R	RTD; Rlin.; mV; pot.; Active or passive 4/20 mA; 0/10 V; 0/5 V
N° of input channels	1 or 2		1
Output signal	Active or passive (choice on the terminals) 4...20 mA	Active or passive (auto)	Active or passive (defined with order) 4...20 mA; 0/10 V; 0/5 V...
N° of output channels	1 or 2 (splitter)		1
HART		Yes, as option	
Accuracy / response time	< 0.2% / < 100 ms T99	< 0.1% / < 1s T99	< 0.1 to 0.2% / 350 ms T99
Consumption power	2.3 W to 4.5 W (2 channels)	3.5 W	2.7 W
Power supply	99 – 253 V AC or 22.6 – 53 V DC	98 – 255 V AC or 21 – 53 V DC	230 V AC; 110 V AC; 24 V DC; 48 V DC
Insulation	2,500 V AC 50 Hz		
Configuration	0 and span by potentiometer	PC (ProgressXmanager)	0 and span by potentiometer



Digital Input ←	RDN1** , 2** ▲●	RDN310/410	RDN213V/W
FUNCTION	Digital input	Bistable relay	Opto-isolator
Input signal (zone)	Contact or proximity sensor (8.2 V)		Contact (100 mA max)
N° of input channels	1 or 2	1(2) or 2(4)	2 or 4
Output signal	SPDT or relay 5 A 250 V / 10 Hz max		
	Transistor 100 mA 65 V / 5 kHz max	-	Transistor 30 V 100 mW max 5 kHz
N° of output channels	1 or 2 (splitter)	1 or 2	2 or 4
Response time	≤ 20 ms (relay); 100 μs (transistor)	≤ 20 ms	-
Consumption power	2.3 W to 4.5 W (2 channels)	3.5 W	-
Power supply	230 V AC or 110 V AC or 12 V DC or 24 to 48 V DC		5 V DC, 12 V DC or 24 V DC
Insulation	2,500 V AC 50 Hz		
Installation	DIN rail / available as a backplane or card mounting		

OPTIONS	Screw-on terminals, alarms, etc.
---------	----------------------------------

CERTIFICATIONS AND QUALIFICATIONS	
ATEX [Ex ia] gas	II (1) G/D [Ex ia] IIC / exists in non-ATEX version
ATEX [Ex ia] dust	
ATEX Ex nA zone 2 gas	▲ Ex nA IIC T4 Gc (depending on the model)
SIL capability	● SIL 2
EAC qualification	✓



## Analog output



	BXNA (I) ▲ ●	BXNI*A
FUNCTION	Analogue output	Current loop isolator
Input signal	Passive 4...20 mA (50 Ohm); 0/10 V; 0/5 V...	4...20 mA
N° of input channels	1	1, 2 or 4
Output signal (zone)	Active 4...20 mA	4...20 mA
N° of output channels	1	1, 2 or 4
HART transparent	Yes, as option	No
Accuracy / response time	< 0.1 to 0.2% / 350 ms T99	< 0.2% / < 100 ms T99
Consumption power	2.7 W	-
Power supply	230 V AC; 110 V AC; 24 V DC; 48 V DC	None
Insulation	2,500 V AC 50 Hz	
Configuration	0 and span by potentiometer	0 by potentiometer



## Digital Output



	BXNE0 ▲ ●	BXNE 1 and 2 ▲ ●	RDN21*V/W
FUNCTION	I.S. power supply	I.S. power supply	Binary isolator
Input signal	-	24 V DC or contact	Transistor: 24.12 or 5 V DC relay: 24, 48 V DC, 110, 230 V AC
N° of input channels	1 or 2		2 or 4
Output signal (zone)	Output voltage, depending on the model 31 models		Transistor 30 V 100 mW max 5 kHz SPDT or relay 5A 250 V / 10 Hz max
N° of output channels	1 or 2		2 or 4
Response time	≤ 20 ms		Relay C < 12 ms, O < 5 ms
Consumption power	3 W		-
Power supply	110 / 230 V AC or 21.6 – 53 V DC		-
Insulation	2,500 V AC 50 Hz		
Installation	DIN rail / available as a backplane or card mounting		
OPTIONS	Screw-on terminals		

## ASSOCIATED PRODUCTS

Pre-wiring cables  
ACCDIVBX...

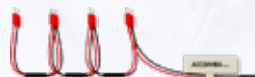

## I.S. displays

The loop-powered GeXi displays can be simply inserted in hazardous area in a 4/20 mA intrinsic safety loop in order to read the process value of the connected equipment.

Thanks to their new electronics, the voltage drop they cause in the loop is limited to 1.2 V.

The design of the shallow housing, the removable connection terminals and the new mountings simplify installation in a housing or cabinet and guarantee perfect interchangeability with older-generation appliances or other makes.

They meet a broad range of need in terms of the installation mode, the dimensions of the screen or the numerous available options, such as back-lighting or alarms.

Configuring the devices has been greatly simplified, thanks to an intuitive interface equipped with push buttons on the front panel.

Georgin is the official representative in France of BEKA, which offers a broad range of products, including standalone intrinsic safety clocks, temperature transmitters with displays, meters, tachometers, Modbus/Fieldbus/Profibus data displays and ATEX sirens and pilot lamps.



GeXi series



	GeXi07	GeXi08	GeXi03
FUNCTION	ATEX Ex i display, loop powered		
Installation	96 x 48 mm panel	144 x 72 mm panel	122 x 120 mm local
Input	4...20 mA		
Display	20,000 pts (4 digits) LCD Height = 15 mm	20,000 pts (4 digits) LCD Height = 34 mm	20,000 pts (4 digits) LCD Height = 34 mm
Configuration	With buttons on the front panel		
Housing / protection	IP66 (front), IP20 (rear)		Fiberglass-reinforced polyester / IP66
OPTIONS	Back-lighting, 2 alarms (transistors)		Backlight, 2 alarms (transistors) Front panel buttons, stainless steel cover plate



	GeXi27	GeXi28	GeXi24
FUNCTION	ATEX Ex i display, loop powered		
Installation	96 x 48 mm panel	144 x 72 mm panel	122 x 120 mm local
Input	4...20 mA		
Display	200,000 pts (5 digits) LCD Height = 11 mm + bar graph	200,000 pts (5 digits) LCD Height = 29 mm + bar graph	200,000 pts (5 digits) LCD Height = 29 mm + bar graph
Configuration	With buttons on the front panel		
Housing / protection	IP66 (front), IP20 (rear)		Glass fibre-reinforced polyester / IP66
OPTIONS	Back-lighting, 2 alarms (transistors)		Back-lighting, 2 alarms (transistors) Buttons on front panel, stainless steel markings plate

CERTIFICATIONS AND QUALIFICATIONS

ATEX [Ex ia] gas	II (1) G Ex ia IIC T5 Ga	
ATEX [Ex ia] dust	II (1) D Ex ia IIIC T80°C Da IP20	II (1) D Ex ia IIIC T80°C Da IP66 (in option)

ASSOCIATED PRODUCTS

2" installation kit



Stainless steel labels and plates



Pilot lamps VSI



Complete BEKA range



## Signal conditioners

The SG family of signal conditioners was developed to guarantee optimal reliability, space-savings and significant savings in terms of installation and maintenance.

The isolation amplifier, separator, signal repeater, transmitter power supply and temperature transmitter functions are all available, guaranteeing ease of use and outstanding performance.

Our unique factory calibration method offers exceptional response times and accuracy.

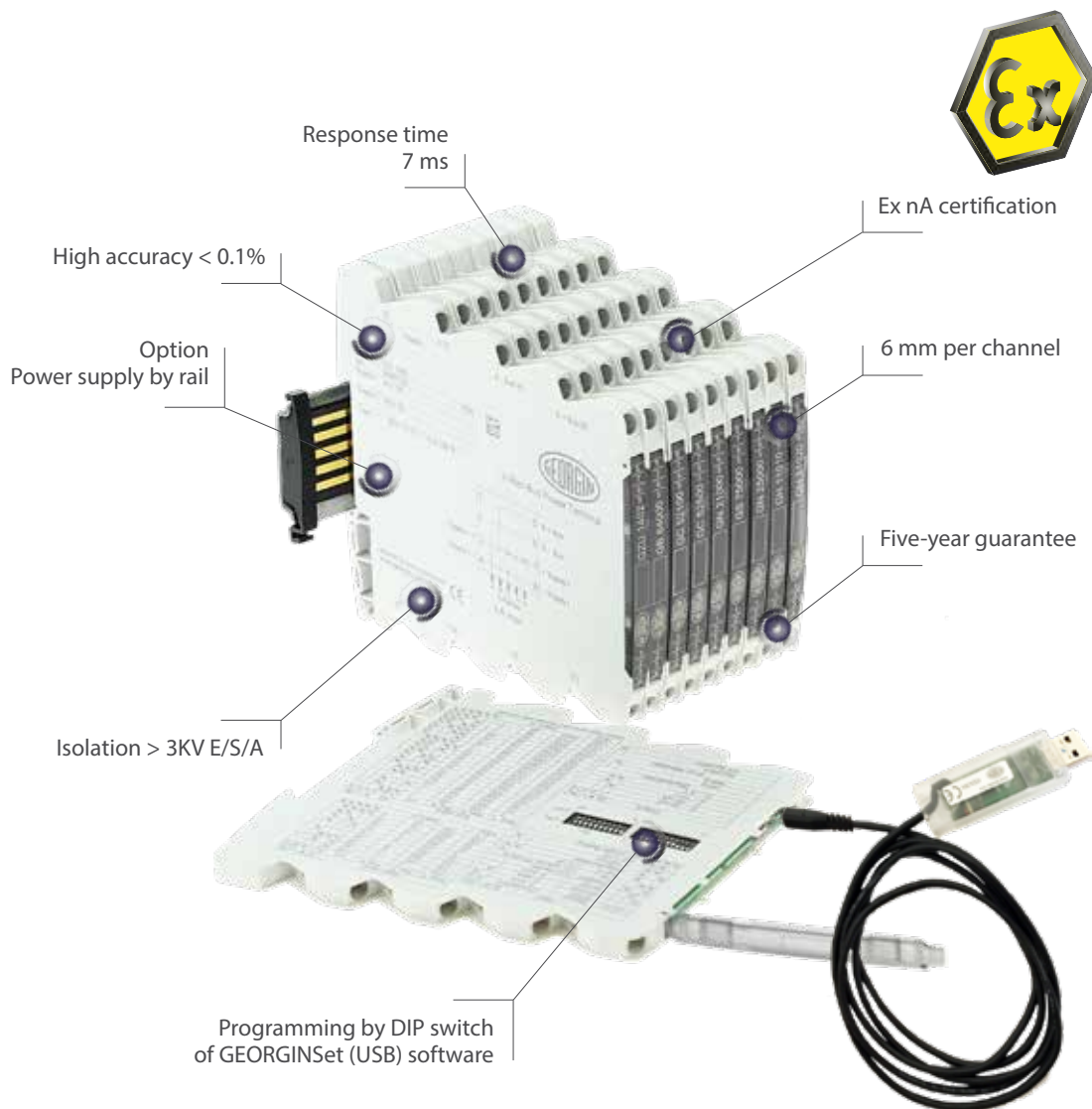





	GB64000	GC52100	GC 52500	GH 110*0
FUNCTION	Bipolar isolation amplifier	Transmitter power supply	HART transmitter Power supply	Loop powered isolator
Input signal	$\pm 0/4 \dots 20$ mA (passive) $\pm 0/2 \dots 10$ V; $\pm 0/1 \dots 5$ V	Tx. 2, 3, 4-wire (17V@20 mA) 0/4...20 mA; 0/2...10 V	Tx. 2-wire (16 V@20 mA) 0/4...20 mA	0/4...20 mA (active) 2.3 V@20 mA voltage drop
N° of input channels	1			1 or 2 (GH11020*)
Output signal	$\pm 0/4 \dots 20$ mA (active) $\pm 0/2 \dots 10$ V; $\pm 0/1 \dots 5$ V	0/4...20 mA (active) 0/2...10 V	0/4...20 mA (active)	0/4...20 mA (passive 600 $\Omega$ )
N° of output channels	1			1 or 2 (GH11020*)
HART conductive	No		✓	No
Accuracy / response time	< 0.1% / 7 ms T90			
Power supply	16.8 to 31.2 V DC / 0.8 W	16.8 to 31.2 V DC / 1.3 W		No
Insulation	3000 V AC 50 Hz			
Configuration	DIP switches		No	

	GN21000	GN25000	GS75000	GT 45000
FUNCTION	Separator / signal repeater	Isolation amplifier	Shunt resistance isolation amplifier / voltages in mV	Universal temperature transmitter
*Switchable input signal	Tx. 2-wire 16 V@20 mA (active)* 0/4...20 mA; 0/2...10 V	0/4...20 mA (passive) 0/2...10 V	$\pm 60$ mV to $\pm 500$ mV 0...60 mV to 0...500 mV	TC: E,J,K,L,N,R,S,T,U/B,C,D Pt; Ni; KTY; mV; pot. current 50 k $\Omega$ resistance 5,000 $\Omega$
N° of input channels	1			
Output signal	0/4...20 mA (active) 0/2...10 V; 0/1...5 V	0/4...20 mA (active) 0/2...10 V	$\pm 0/4 \dots 20$ mA (active) $\pm 0/2 \dots 10$ V; $\pm 0/1 \dots 5$ V	0/4...20 mA (active) 0/2...10 V; 0/1...5 V
N° of output channels	2		1	
HART conductive	No		-	
Accuracy / response time	< 0.1% / 150 $\mu$ sT99	< 0.1% / 7 msT99		<0.1%
Power supply / consumption	16.8 to 31.2 V DC / 1.4 W	16.8 to 31.2 V DC / 0.7 W	16.8 to 31.2 V DC / 0.8 W	
Insulation	3000 V AC 50 Hz			
Configuration	DIP switches			DIP / PC switches

CERTIFICATION

Ex nA IIC T4 Gc

ASSOCIATED PRODUCTS

GEORGINset  
programming kits



22 mm BPX, BV\* modules  
for specific applications



Powered rail  
installation  
accessories



## Conventional displays

The GSI family of panel-mounted universal indicators are designed to be installed outside ATEX areas. The universal input makes the appliances much easier to use. Their options (alarm or 4/20 mA duplication) offer greater flexibility.

The input or alarm thresholds (threshold, time delay, hysteresis, etc.) are programmed using the keys on the front panel.





	GSI40	GSI48
<b>FUNCTION</b>	Universal input display	
<b>Installation</b>	Panel 48 x 96 x 90 mm	
<b>Input</b>	Universal, 4...20 mA, $\pm 20$ mA, $\pm 10$ V, potentiometer, Pt100, Pt1000, thermocouple	
<b>Display</b>	20,000 pts (4 digits) LCD Height = 14 mm	40,000 pts (4.5 digits) LCD Height = 14 mm
<b>Display colour</b>	Red	Red, amber or green (selectable)
<b>Refresh rate</b>	50 ms	50 ms (process), 100 ms (TC), 250 ms (Pt100)
<b>Resolution</b>	16 bits	
<b>Stroke rate</b>	20 strokes per second	
<b>Accuracy</b>	$\pm 0.1\%$ + 1 digit	
<b>Configuration</b>	With buttons on the front panel	
<b>Housing / protection</b>	IP65 (front), IP20 (rear)	
<b>Working temperature</b>	-10 °C to +60 °C	
<b>Power supply</b>	Universal : 12 to 265 V DC and 20 to 265 V AC	AC : 85 - 260 V AC / 100 - 300 V DC DC : 10 - 70 V DC / 21 - 53 V AC
<b>Consumption</b>	3W	5 to 8 W, depending on the outputs
<b>OPTIONS</b>	Two relay outputs with inverter contact as an option 260 V AC / 1A / 150 VA	Output 4...20 mA Factory calibration with test report Relay outputs with inverter contact (x2) 260 V AC / 1A / 150 VA Relay outputs with dry contact (x2) 260 V AC / 0.1A / 50 VA

Customer applications



OTV 

Drinking water treatment

OTV



 MPR Industries  
A World of Solutions

Industrial compressors

MPR



 BOREALIS  
Keep Growing

Signal processing in chemicals factory

Borealis

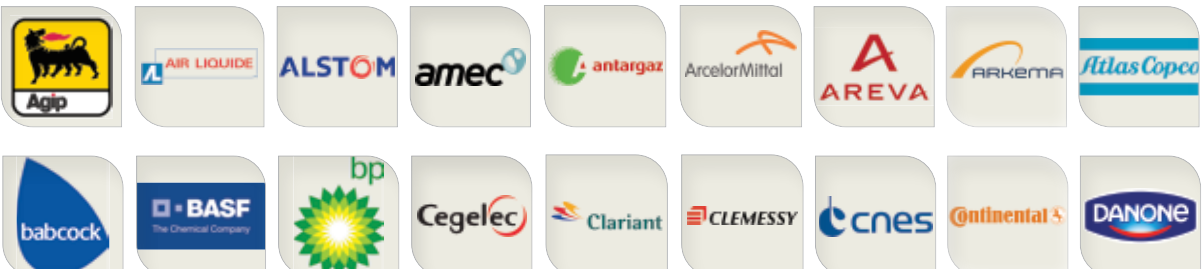

Customer applications



Urban heating

Soclis / Dalkia



Gas storage

Storengy



Spatial

Kourou / Ariane 5 launch pad





Customer applications



Fuel storage  
ADP (Paris airports)



Drinking water treatment  
Re-circulation pumps



Pressure monitoring  
Hydraulic power station







ATEX company certification



EDF certification



ISO 9001 V2008



Engie-Electrabel certification





Safety for Industrial Process



"Designed, developed and manufactured in France "

## Régulateurs GEORGIN

France

14-16, rue Pierre Sépard - BP 107 - 92320 Châtillon Cedex France  
Tel.: +33 (0)1 46 12 60 00 - Fax: +33 (0)1 47 35 93 98 - Email: [regulateurs@georgin.com](mailto:regulateurs@georgin.com)

Belgium

Temselaan 5 - 1853 STROMBEEK-BEVER  
Tel.: + 32 (0)2 735 54 75 - Fax: + 32 (0)2 735 16 79 - E-mail : [info@georgin.be](mailto:info@georgin.be)

Germany Georgin GmbH - Schultenhofstraße 22a - 45475 Mülheim Ruhr  
Tel.: +49 (0)208 88 27 89 0 - Fax: +49 (0)208 88 27 89 20 - Email: [sales@georgin.de](mailto:sales@georgin.de)

Asia

Rooms 1101A-4 on 11/F China Evergrande Centre/Mass Mutual Tower - 38 Gloucester Road - Hong Kong  
Tel.: +86 021 6352 6216 - Fax: +86 (021) 6352 6217 - Email : [china@georgin.com](mailto:china@georgin.com)

[www.georgin.com](http://www.georgin.com)