

ENGINEERING
YOUR SPRAY SOLUTION

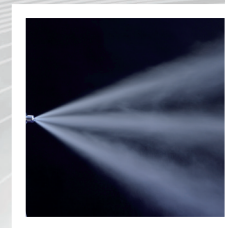

Nozzle Lances and Systems for Gas Denitrification

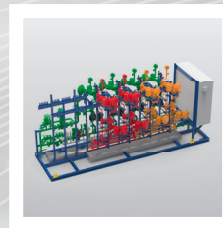
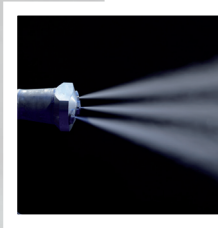
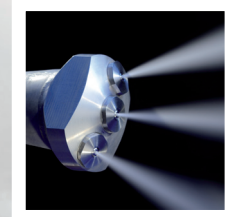
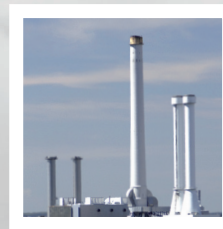

VarioClean[®] - NOx

EFFICIENT COOLING AND CONDITIONING WITH LECHLER NOZZLE LANCES AND SYSTEMS

Lechler is Europe's No. 1 choice and is one of the leading nozzle and systems providers worldwide. For over 135 years, we have pioneered numerous groundbreaking developments in this field. We combine comprehensive nozzle engineering expertise with a deep understanding of application-specific requirements to create products that offer outstanding performance and reliability.



Innovative solutions for a trending market

Lechler is your innovative and reliable partner in all matters relating to gas cooling and conditioning. Always with the aim of employing our expert knowledge to optimize your process.

Efficient gas conditioning offers a wide range of approaches to reduce costs and increase efficiency. A prerequisite is that the respective processes are

thoroughly understood and that the gas conditioning is adapted accordingly.

The right solution for every requirement

With our wide range of nozzles and gas conditioning systems, we offer the perfect solution for every application. Every plant naturally comes with its own set of challenges.

Our nozzle lances and systems have proved in different applications and plants all over the world:

- Cement and lime industry
- Waste incineration plants
- Power plants
- Steel industry
- Glass industry
- Chemical industry

We rise to these challenges and work with you to develop the best solutions for your business. We support you with comprehensive consulting services ranging from process analysis to turnkey solutions.

1879



Company founded by Paul Lechler

1893



Patent for liquid atomization

1962



Sales offices set up in Germany

1978



Expansion into the USA, followed by further countries

COMPETENCE – THE ADVANTAGE OF MULTIPLE PERSPECTIVES

For many years now, nozzles and spray systems for industrial gas conditioning has been an integral part of our Environmental Technologies portfolio. An international team of outstanding engineers and process engineers continuously develop new solutions and adapt them to new challenges.

Through the use of global databases and close cooperation with external specialized institutes and renowned plant manufacturers, we have built up an interdisciplinary knowledge base – and with it optimal process integration.

Our constant exchange of experiences with plant operators means we are always in tune with the latest developments.

To provide you with local support, we are represented all around the globe – with locations in the USA, Great Britain, India, China, ASEAN, France, Belgium, Italy, Finland, Hungary, Spain and Sweden, as well as sales partners in almost every country.

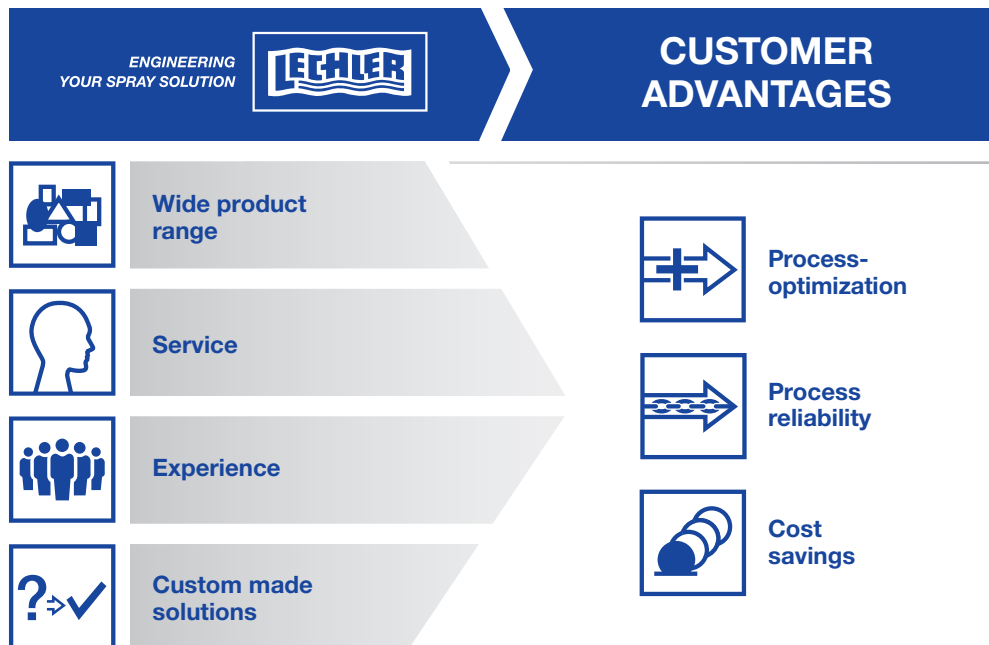

Costs under control

In most processes with hot offgases generally extreme environmental conditions prevail. We manufacture our nozzles from highly resistant materials with minimal wear.

The long service life of our high-quality components for valve skid units and systems does not just reduce the pure costs of spare parts, but also decreases downtimes and maintenance costs. In addition, customer-specific systems lower the operating costs to a minimum.

Twin-fluid nozzles allow for an application-optimized fine droplet spectrum, whereas spillback systems do away with compressed air altogether to reduce the energy consumption.

Our job is to identify the appropriate solution in each case and then adapt it perfectly to the on-site conditions.

1988



Environmental Technologies division founded

1995



Production, sales and administration in Metzingen

2010



Opening of the new 13,000 m² production hall in Metzingen

2016



Opening of the new Development and Technology Center in Metzingen

LECHLER PRODUCTS PROVE THEMSELVES IN MANY APPLICATIONS

With our broad portfolio of denitrification solutions we support you in multiple applications. If you are missing a specific scenario, don't hesitate to contact us. We are glad to discuss different options and provide the optimum answer to your needs.

Cement plant SNCR in calcinator

SNCR process in a calcinator.

- Optimum mass transfer between the reducing agent and flue gas, e.g. via twin-fluid flat spray nozzles.

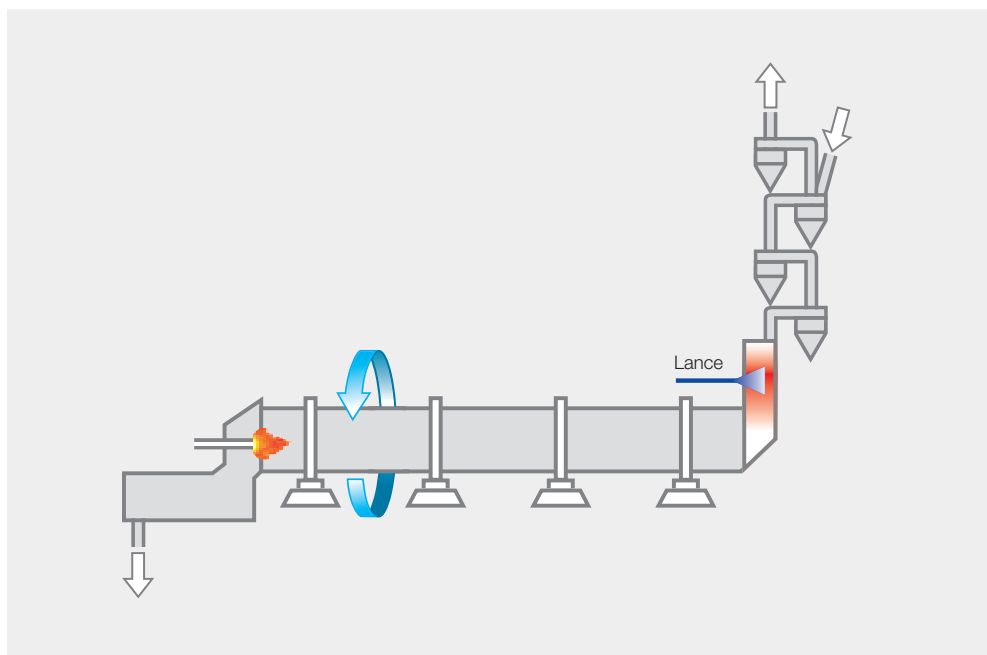

Waste incineration plant SNCR

SNCR process in waste incineration plant.

- Very good controllability of droplet size/pulse rate so that fluctuating NOx concentrations can be counteracted.

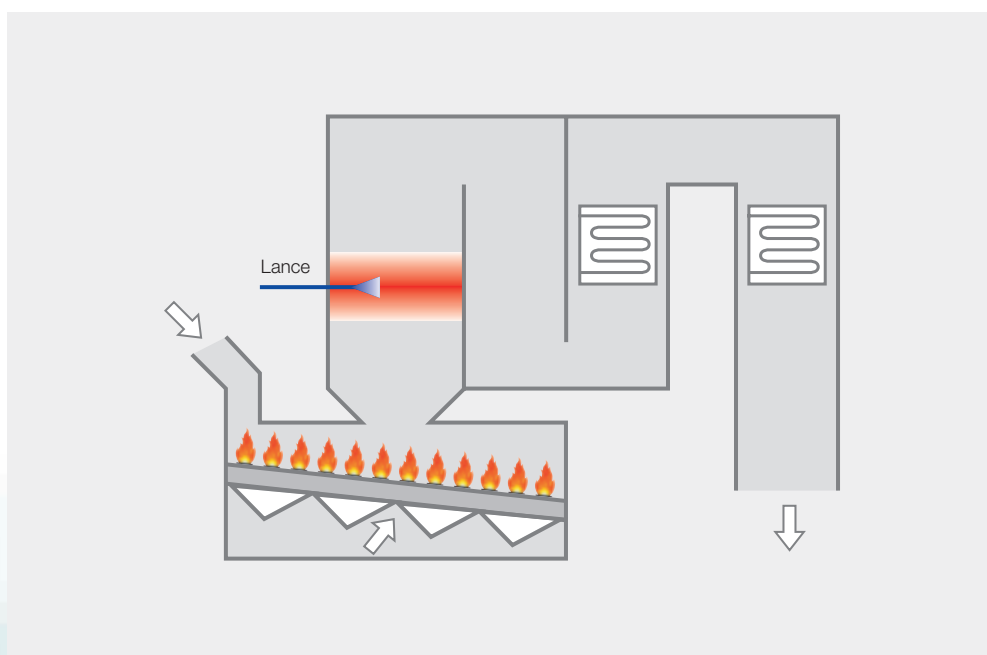

**Cement plant
SNCR in long kiln**

SNCR process in the long cylindrical rotary kilns of cement works.

- Process for denitrification directly in the kiln, including media routing along the rotary kiln.

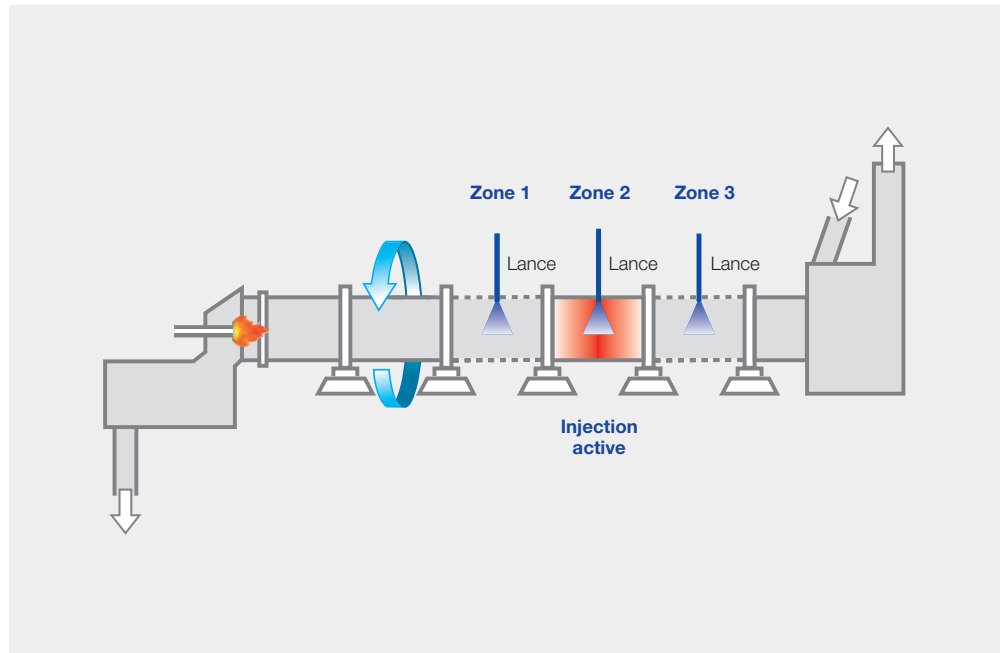

**Power plant
SCR**

SCR process in large power stations.

- New nozzle technology for very short evaporation paths (patent).

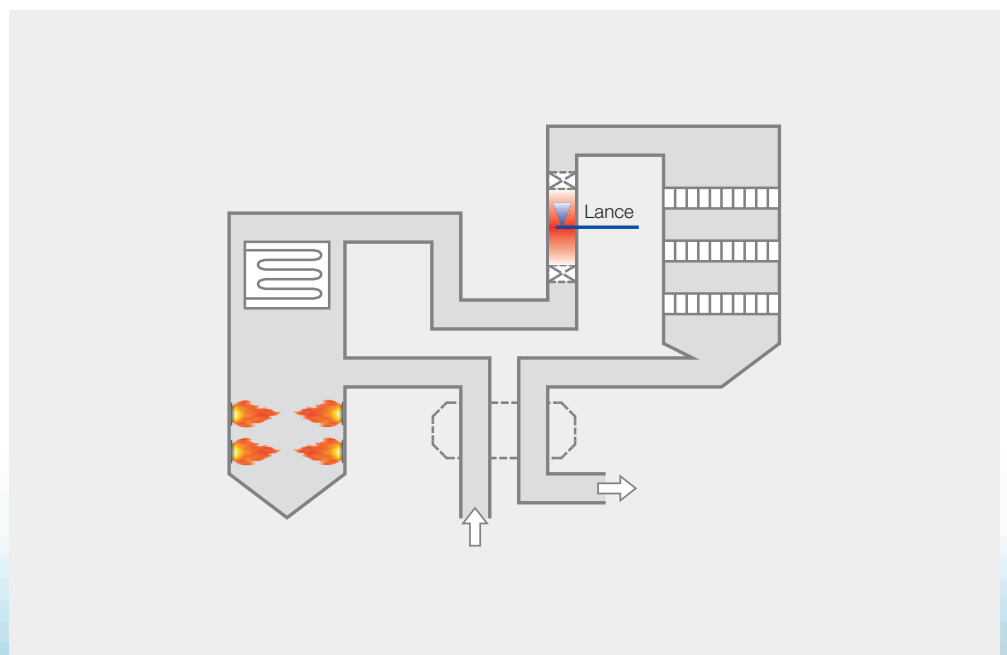

Special twin-fluid nozzles for DeNOx applications

Laval nozzle

In DeNOx applications with SNCR processes, small Laval nozzles are usually used. These nozzles are characterized by a high discharge velocity, enabling the optimum droplet spectrum to be introduced into the reactor

with a great penetration depth. Our research has shown that the discharge velocity has a greater effect on the denitri-fication process. Moreover, these nozzles without internals are extremely insensitive to clogging and can be precisely controlled.

See page 15 for more information

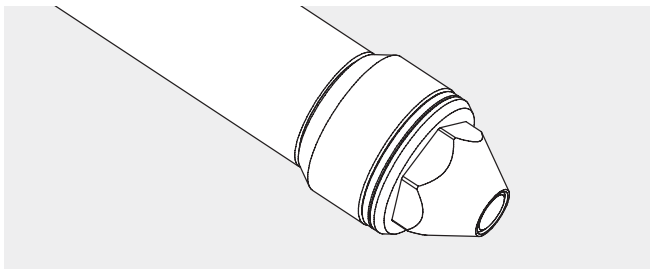

Special properties



Small spray angle (15°), suitable for small cross-sections and horizontal ducts



Turn-down ratio of 20:1 (in some cases up to 40:1)



Typical pressure range
Liquid 1-6 bar, g
Atomizing air 1-6 bar, g



Adjustment of the droplet spectrum by changing the air/ fluid ratio



Very fine droplet spectrum



Spray pattern of a Laval nozzle

For SCR processes and special SNCR processes there are special nozzles which have been developed to meet the specific requirements. The same principles regarding control and operation apply for all twin-fluid nozzles, irrespec-tively of the type.

Laval flat fan nozzle

The Lechler Laval flat fan nozzle atomizes according to the principle of inside mixing. The air/fluid mixture exits via three outlet holes creating a wide and flat spray with an even better surface coverage.

The droplet spectrum and the pulse of the droplets can be adapted by changing the air/ fluid ratio.

Special properties



Wide and flat jet, spray angle 60°



Turn-down ratio of over 10:1



Typical pressure range
Liquid 1-5 bar, g
Atomizing air 1-5 bar, g



Spray alignment possible



Adjustment of the droplet spectrum by changing the air/ fluid ratio

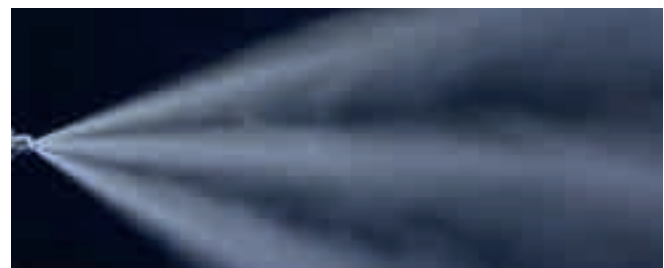
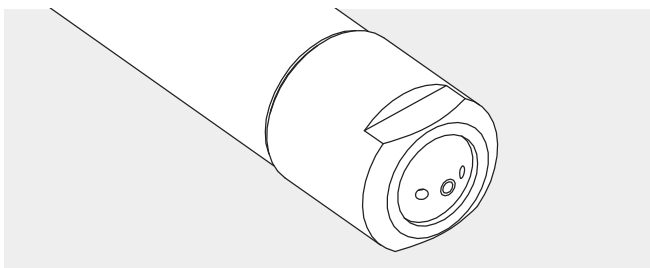

Spray pattern of the flat fan nozzle

MasterNOx® for DeNOx processes

The Lechler MasterNOx® nozzles are usually used in the non-catalytic denitrification of flue gases (SNCR process). They are usually designed as flat fan nozzles and achieve a high spraying range to make the liquid penetrate as far as

possible into the boiler. The nozzle specially developed for the retrofitting of existing power plants is characterized by a small outer diameter, so that it can fit between the pipes of the boiler wall. It can also have a protective flow of barrier air around it without the need for the pipes to be bent aside.

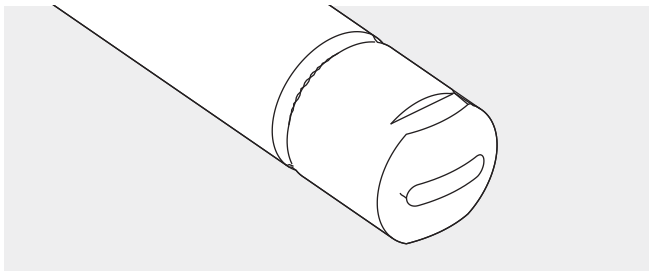

Special properties



Spray angle
15°, 30°, 60°



Turn-down ratio
of over 50:1



Typical pressure range
Liquid 1-10 bar, g
Atomizing air 1-6 bar, g



Adjustment of the droplet spectrum by changing the air/water ratio



Spray pattern of the MasterNOx® nozzle 30°

1AW nozzle

The Lechler 1AW nozzle works according to a newly developed and patented atomization principle. It divides the supplied atomizing air into a primary and secondary air flow. Thanks to the specific inflow geometry, the secondary air exits through an annular gap causing a very fine atomization in the edge region of the spray.

This twin-fluid nozzle enables finest droplet spectra and shortest evaporation distances while also allowing very good controllability of the flow rate. Cluster heads designed specifically for these nozzles multiply the flow rates and adapt the spray pattern to the requirements at the point of injection.

Special properties



Spray angle of the individual nozzle
15° as full cone



Particularly fine droplets thanks to tertiary atomization



Turn-down ratio
of 10:1



Design
as single or bundle nozzle lances



Typical pressure range
Liquid 1-5 bar, g
Atomizing air 1-5 bar, g



Adjustment of the droplet spectrum by changing the air/fluid ratio



Single nozzle without barrier air
Spray angle 15°; full cone

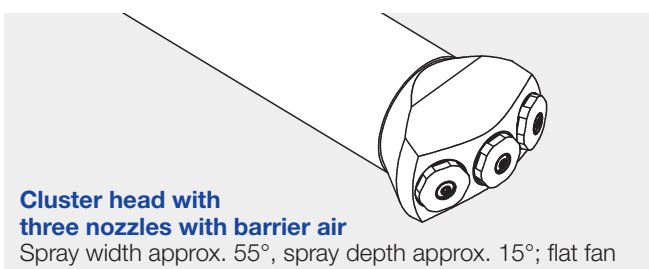

Cluster head with three nozzles with barrier air
Spray width approx. 55°, spray depth approx. 15°; flat fan



Spray pattern of the 1AW nozzle

SmartNOx®

The powerful starter system

Lechler SmartNOx® is the entry-level system for the SNCR process. Standardized units with fixed components allow for affordable pricing, all while maintaining Lechler's famous high quality standard.

Included with delivery are a valve skid unit including pumps and fittings for media control as well as individual modules enabling the lance levels to be connected and disconnected. The components of the valve skid unit are connected with pipes and assembled on a compact base frame including all brackets. Assembling in a two-door closed cabinet is also possible as an option.

Features:

- Two sizes
- Reducing agent injection quantities of 0.005 – 1.0 m³/h or 1.0 – 2.7 m³/h
- Frequency-controlled pumps with magnetic couplings (duplicated)
- Permanently technically sealed in accordance with DIN EN 1127-1
- Optional integrated gas detector
- Integrated drip tray
- In accordance with DIN EN 1295 2-14: X-ray examination of 10% of all welds capable of validation
- 3.1 material certificates in accordance with DIN EN 10204
- Integrated flush connection
- Integrated air flushing for non-active levels
- Standardized technical documents for simple implementation in higher-level operating documentation

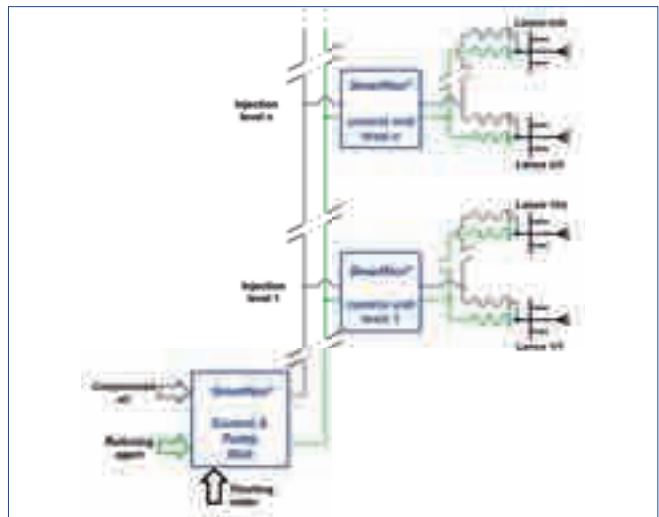
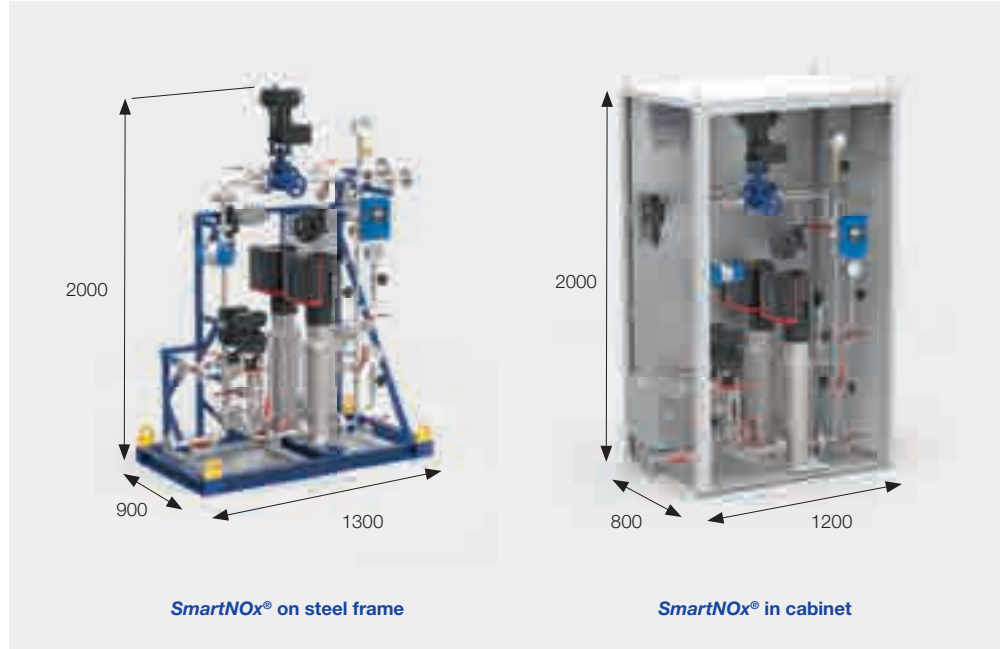

Lechler SmartNOx® system

The Lechler SmartNOx® system is an independent SNCR system and is not designed for later upgrading with more efficient Lechler systems.

VarioClean® - NOx

The denitrification solution that grows with you

The limit values for NOx emissions and ammonia slip (NH₃ slip) are expected to be reduced further in the coming years. To enable a profitable production of cement all the same, processes must be observed and optimized with intelligent control strategies.

For this purpose, Lechler has joined forces with STEAG to develop an SNCR concept that reliably ensures compliance with the limit values in force: VarioClean® - NOx.

Three steps for any requirement

Depending on (what is required by) the legal situation, the modular system VarioClean® - NOx can be flexibly upgraded across the three configuration levels Basic, Efficiency and High Efficiency SNCR. The base frame and the base modules are identical for all three configurations. The difference lies in the number of lances and injection levels, as well as in the software and sensor packages for the successful control of all necessary influencing factors.



Basic SNCR

The control of flue gas denitrification is based on a NOx measurement at the flue. Both aqueous ammonia and urea can be used as a reagent for the denitrification. All existing lances are controlled by the conventional control – depending on the NOx concentration measured. The Basic SNCR is primarily used where comparatively high NOx limit values or no limit values must be observed for the NH₃ slip and there are very stable temperature conditions.

The base frame of the valve skid unit and the installed fittings are designed for later upgrading. Further lances can be integrated using additional distributor pieces. Since individually controllable lances can be used from the start, a Basic SNCR system can be extended to both of the next configurations without any problems.

Efficiency SNCR

In the case of higher requirements in terms of the limit values to be complied with and less stable temperature conditions, the "efficiency SNCR" (eSNCR) with a larger number of lances is ideal. The lances are installed on at least two levels and each lance is individually supplied with the reagent.

In addition, a software-based "intelligent controller" is connected with the PCS via an interface and supplied with current process signals. This allows the NOx concentration in the raw gas to be estimated and thus enables a more accurate and more economical dosing of the reagent.

High Efficiency SNCR

The "high efficiency SNCR" (heSNCR) meets the highest NOx reduction demands while at the same time keeping reagent consumption to a minimum. It has further lances, which are normally installed on at least three different levels. The control is extended to include online CFD simulating the temperature and flow conditions in the injection area. Together with the estimated amount of NOx in the raw gas and the NOx concentration measured in the clean gas at the flue, the spray behavior of each lance can be individually controlled for an optimal use of the reagent.

The scopes of delivery for the 3-level SNCR are as follows:



A total of up to 10 lance units can be flexibly mounted on the base frame. Irrespectively of the respective SNCR level, the basic structure includes the junction box, the drip tray and all necessary brackets for the respective units.



Video: SNCR concept with STEAG

<http://www.lechler.de/lechlersteagsnrc>



Controlled section of a heSNCR

Benefits:

- Systems grow with the legal requirements
- No unnecessary investments
- Modular design in three upgradable configuration levels
- Optimal reagent use resulting in reduction of operating costs
- High NOx reduction (suitable solutions for requirements of differing complexity)
- Low NH₃ slip (adapted solutions for reduction of NH₃ slip)

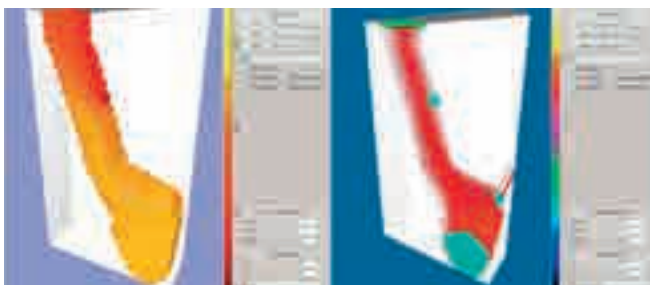

Signal analysis and online-CFD



Talk to us

Different systems require different strategies. The largest and most comprehensive solution is not always the best one. Let us discuss your requirements and work together to find the denitrification system that is a perfect fit today and will grow tomorrow to keep up with rising demand.

CFD

Flow optimization with computational fluid dynamics

The flow behavior of gases is significantly determined by the geometry of the environment. By applying computer simulation using computational fluid dynamics (CFD), our specialists can detect unequal gas distributions as well as turbulence. Depending

on the specific conditions, these issues can be resolved in different ways. Installing baffles, perforated plates or even repositioning nozzles can be simulated to achieve the desired flow characteristics. The result of optimized gas flow via CFD can significantly reduce energy and/or material requirements.

Optimization of the gas flow in the gas cooling tower

Benefits:

- Efficient cooler operation thanks to lower atomizing air consumption and/or lower connection pressures at the nozzle lances
- Wet ground avoided as well as possible caking on the inner wall of the cooler
- Stable process in various load cases

Before

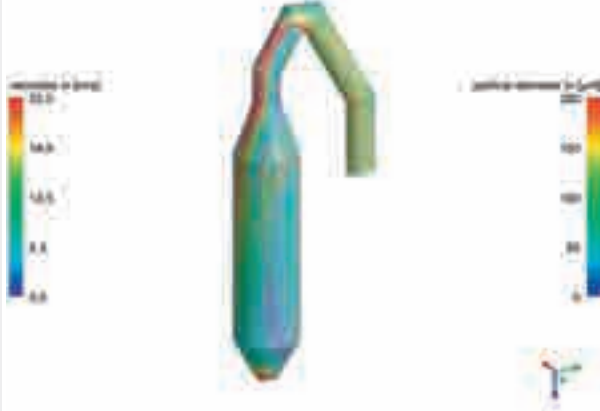

After



Optimization of SNCR process – best possible selection and placement of nozzles

Benefits:

- Reactive ammonia vapor is present where the gas containing nitrogen (NOx) flows
- Avoidance of unnecessary NH₃ slip, meaning efficient use of the ammonia solution
- Best possible reduction rates of nitrogen oxides

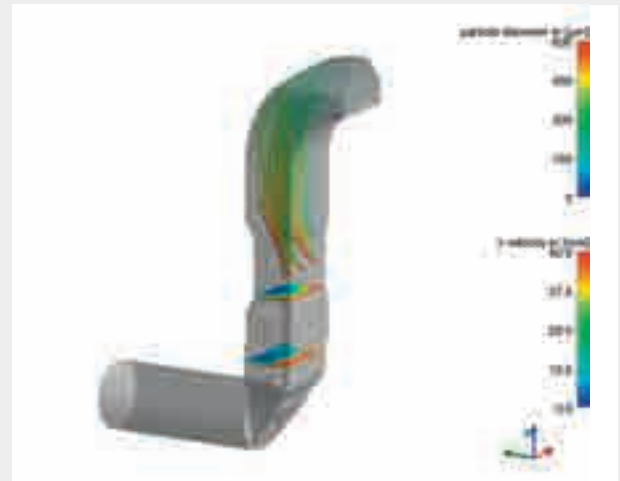

Design and continuous optimization of our products

Benefits:

- Optimal atomization effect
- Efficient use of the connected atomization media
- Reduction of the required nozzle connection pressures
- Individual nozzle development in the shortest time

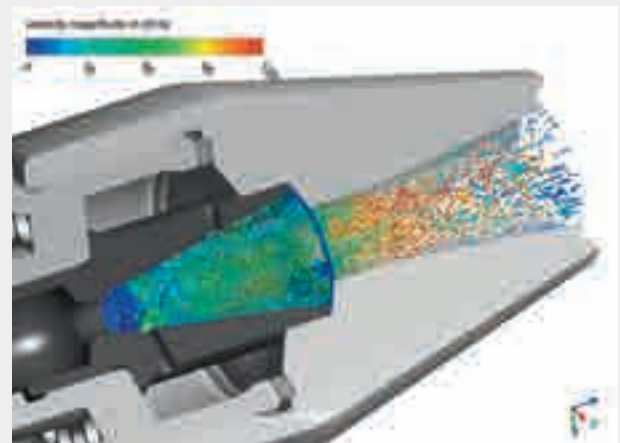

ENGINEERING AND SERVICE

Our experience for your success

With our experienced engineering team, you have a competent contact for your project at all times – from technical design and detail engineering to commissioning and the replacement of spare and wearing parts. You will benefit from direct contact and fewer communication channels to enable smooth completion of your project.

From digital to real

Each individual design of gas cooling and conditioning systems is based on innovative software. CFD calculations are used for flow optimization. Using a 3D tool, we identify the optimum liquid distribution in the duct together with the necessary lance arrangement.

Our drawings are created using state-of-the-art design engineering software.

Exclusive solutions

Lechler offers a system solution tailored to your application and plant-specific conditions. We use only high-quality components from renowned manufacturers for our valve skid units. If you choose a system with a control, you will get a complete solution for your gas cooling and conditioning requirement from a single source.

Extensive documentation

Our nozzle lances and systems are designed and manufactured in line with the current standards and regulations. New plants are always delivered with project-related documentation containing all relevant information for commissioning, operation and maintenance. Lechler will also provide a verbal description of the function and control concept where desired.

Reliable service is part of our agreement

Lechler is Europe's No. 1 nozzle manufacturer. A key factor for this success is our service. For even after your system has been delivered, you are in good hands with Lechler. We offer a worldwide commissioning service provided by employees with many years of experience. A signal and performance test ensures optimal system operation taking all operating and safety aspects into consideration. An important point of commissioning is also the detailed briefing of operating and maintenance personnel in the operation and maintenance of the plant.

We are your competent partner who will provide you with assistance to solve your problems. Our on-site service for preventive maintenance ensures continuous operation. We will be more than happy to draw up a maintenance contract tailored to your needs.

Future-proof

Lechler systems are built to withstand harsh conditions and enable reliable and long-term operation. But we too have to lend to extreme process conditions as e.g. in SNCR processes. Which is why it is all the more important to us to have a guaranteed long-term supply of spare parts for wearing parts – worldwide. With our global network of representatives, we offer a worldwide platform for contact and advice. You will find your competent contacts on the Lechler website.





Our USP: Practice-based knowledge

Since it was founded, Lechler has stood out for its development of new technologies. In more than a century we have successfully filed a large number of patents. Starting with the "Centrifugal Sprayer" from 1893 and going up to state-of-the-art technologies of the 21st Century. We will continue this proud tradition into the future, and our new technical center will be key to doing so. After seven years of construction, the Lechler Development and Technology Center was opened in the summer of 2016. Since then it has offered everything nozzle developers dream of on a surface of over 600 m². In addition to extensive measuring facilities, state-of-the-art test benches with a wide range of pump performances are available to measure and investigate sprays, from microfine mist to fuller sprays with varying jetting characteristics.

MEASURING TECHNOLOGY – THE LECHLER DEVELOPMENT AND TECHNOLOGY CENTER

There are many good reasons for the success of our products. One very important factor is that we know what we are doing before we do it.

At Lechler, exact measurements have long been the basis for clearly defined spray characteristics. The data obtained in our laboratories form the foundation for any

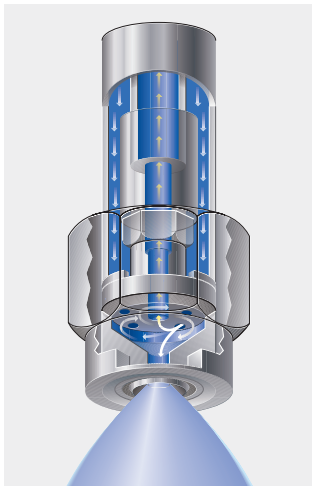

development and make it easier for our customers to choose nozzles for specific applications. This saves time, lowers costs and provides planning security.

Advanced technology

We have further expanded our research capacities by opening our own Development and Technology Center.

A highlight here is a laser-assisted phase doppler anemometer.

As one of the most modern optical measuring procedures, it measures the velocity and the diameter of spherical droplets simultaneously and without contact. Using the data obtained, spectra can

be reliably derived for particle size distributions and velocities. Measurements range from tiny water droplets in the micrometer region to very large droplets of around 8 millimeters. These are performed with a high temporal and spatial resolution.

Individual positions in the spray can be automatically approached and measured with extremely high accuracy – in x, y and z directions.

International cooperation

We at Lechler value the importance of international cooperation. For this is often what opens up new perspectives on a problem. In addition, cooperation offers us the possibility of testing nozzles in very special test environments and of discovering new use scenarios in this way.



MEASURING TECHNOLOGY – THE LECHLER DEVELOPMENT AND TECHNOLOGY CENTER

Our measurement range:

- Precise and reproducible measurement of droplet sizes and speeds in sprays
- Measurement of complete sprays or of local positions in a spray
- Documentation of the spectra for particle size distribution and velocities
- Determination of the Sauter mean diameter and of many other variables relevant for process engineering
- Measurement of very dense sprays using state-of-the-art laser technology
- Measurement of tiniest droplets in the μm region and measurement of very large drops of up to 8 mm
- Measurement of droplet velocities up to 200 m/s
- High temporal and spatial resolution
- Positions in the spray can be automatically approached and measured with extremely high accuracy – in a 3-dimensional space in x, y and z directions
- Very large measuring range allows measurement of very wide particle spectra
- The size and velocity of each individual droplet is detected
- Error-free results in accordance with ISO 9001
- Spray characteristics over area mapped in 3D
- Detection of positive and negative velocity components

Measurement validation of our calculation models taking the example of a gas cooling tower

Key figures of our experimental cooler with industry partners:

- Approx. two megawatts of thermal performance
- Use of single-fluid and twin-fluid nozzles under the most realistic conditions possible
- Flexible variation of inlet and outlet temperatures
- Monitoring of droplet sizes and numbers in several levels
- Detection of the evaporation rates of injected sprays
- Use of more than 50 sensors of different kinds for the precise detection of all operating parameters



QUALITY WITH A SYSTEM

Lechler products are used in a wide variety of sectors and applications.

Which is why the products' requirements are often very specific to certain applications. We define the term "quality" as the extent to which our products fulfill our customers' individual requirements.



We are certified to ISO 9001 – 2008. Conscientious working and constant quality controls have always been carried out at Lechler, from materials receiving, development and production right through to shipping. So that our products keep what we promise in their daily use.



Talk to us

Your requirements are the first step towards a solution. We are more than happy to help you solve your individual tasks. Tell us your objectives and we will take care of the solution. If the solution is not yet available, we will tailor-make one for you. That is our promise.

FOR YOUR QUESTIONS

QUESTIONNAIRE

Nobody knows your process and requirements better than you. Your knowledge is critical to us in order to find the optimal nozzle for your application.

Simply send us the completed questionnaire or enter your information online.



Data collection sheet for design of a DeNOx system

www.lechler.de/environmental/questionnaire_denox

The image shows a 'Data collection sheet for calculating a DeNOx system' form. It includes the Lechler logo and 'ENGINEERING YOUR GREAT SOLUTION' tagline. The form is divided into sections: '1. General information' (Company, Address, Contact person, Phone, Fax, E-mail), '2. DeNOx data' (Gas composition, Gas flow, NOx concentration, NOx reduction, NOx reduction efficiency, NOx reduction rate, NOx reduction efficiency, NOx reduction rate, NOx reduction efficiency, NOx reduction rate), and '3. General conditions' (Nozzle type, Nozzle size, Nozzle material, Nozzle length, Nozzle diameter, Nozzle pressure, Nozzle temperature, Nozzle environment, Nozzle location, Nozzle orientation, Nozzle installation, Nozzle maintenance, Nozzle inspection, Nozzle testing, Nozzle certification, Nozzle approval, Nozzle registration, Nozzle licensing, Nozzle authorization, Nozzle accreditation, Nozzle certification, Nozzle approval, Nozzle registration, Nozzle licensing, Nozzle authorization, Nozzle accreditation). At the bottom, it provides contact information for Lechler GmbH, including the address '42699 Solingen, Germany', phone number '+49 2122 962-0', fax number '+49 2122 962-400', and website 'www.lechler.com'.

FULL INFORMATION IS JUST A CLICK AWAY: THE LECHLER WEBSITE



Our website contains further information on our products as well as useful resources.

www.lechler.com



FOR YOUR NOTES





**ENGINEERING
YOUR SPRAY SOLUTION**



LECHLER WORLD-WIDE

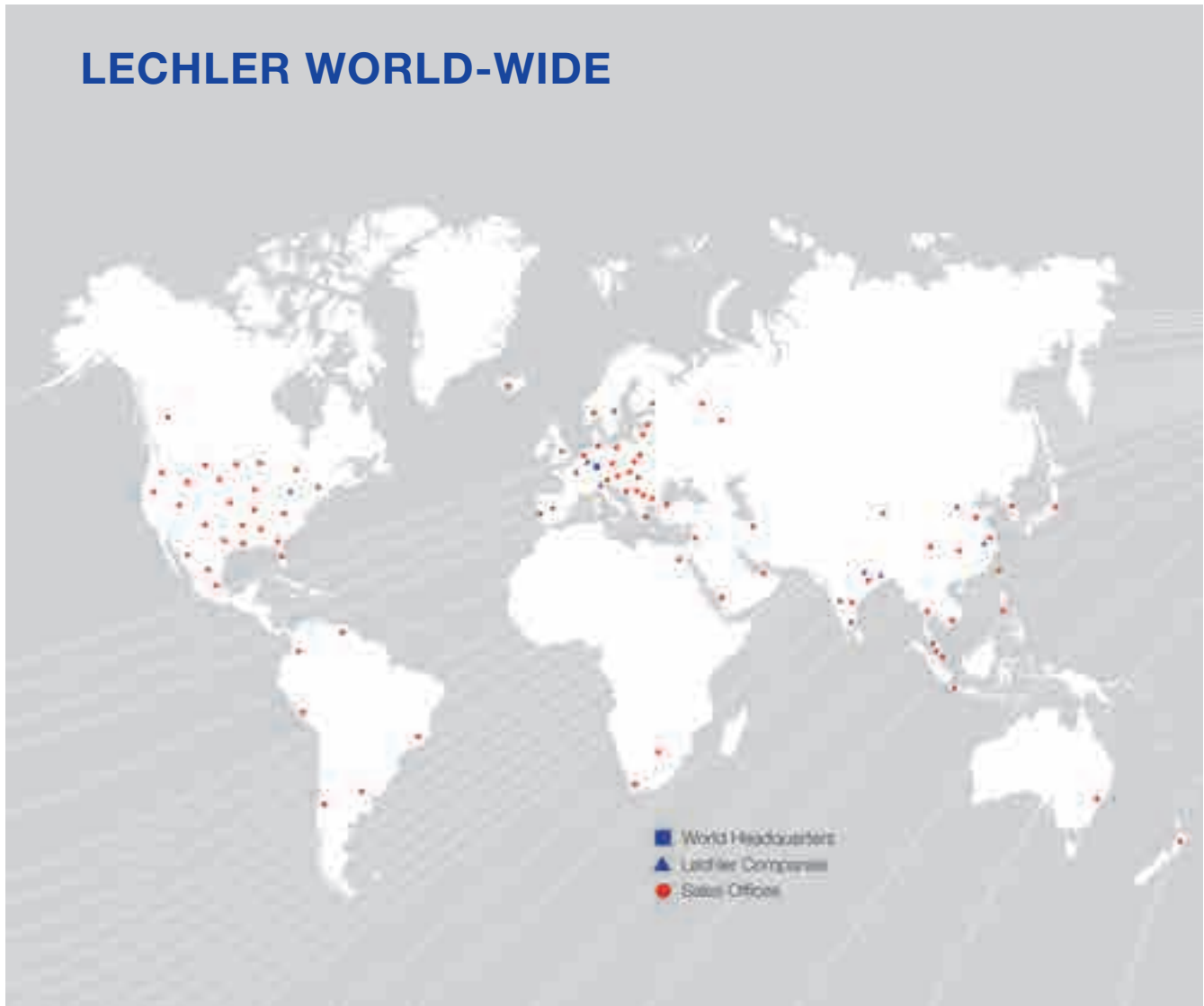

Lechler GmbH · Precision Nozzles · Nozzle Systems

P.O. Box 13 23 · 72544 Metzingen, Germany · Phone: +49 7123 962-0 · Fax: +49 7123 962-301 · info@lechler.de · www.lechler.com

Belgium: Lechler S.A./N.V. · Avenue Mercatorlaan, 6 · 1300 Wavre · Phone: +32 10 225022 · Fax: +32 10 243901 · info@lechler.be

China: Lechler Intl. Trad. Co. Ltd. · Beijing · Rm. 418 Landmark Tower · No. 8 Dong San Huan Bei Lu · Phone: +86 10 84537968, Fax: +86 10 84537458 · info@lechler.com.cn

Finland: Lechler Oy · Jäspiilänkatu 18 · 04250 Kerava · Phone: +358 207 856880 · Fax: +358 207 856881 · info@lechler.fi

France: Lechler France, S.A. · Bât. CAP2 · 66-72, Rue Marceau · 93558 Montreuil cedex · Phone: +33 1 49882600 · Fax: +33 1 49882609 · info@lechler.fr

Great Britain: Lechler Ltd. · 1 Fell Street, Newhall · Sheffield, S9 2TP · Phone: +44 114 2492020 · Fax: +44 114 2493600 · info@lechler.com

India: Lechler (India) Pvt. Ltd. · Plot B-2 · Main Road · Wagle Industrial Estate · Thane (W) · 400604 · Phone: +91 22 40634444 · Fax: +91 22 40634497 · lechler@lechlerindia.com

Italy: Lechler Spray Technology S.r.l. · Via Don Dossetti, 2 · 20080 Carpiano (Mi) · Phone: +39 02 98859027 · Fax: +39 02 9815647 · info@lechleritalia.com

Malaysia: Lechler Spray Technology Sdn. Bhd. · No. 23, Jalan Teknologi 3/3A · Taman Sains Selangor 1 · Kota Damansara, PJU 5 · 47810 Petaling Jaya · Malaysia · info@lechler.com.my

Sweden: Lechler AB · Kungsängsvägen 31 B · 753 23 Uppsala · Phone: +46 54 137030 · Fax: +46 54 137031 · info@lechler.se

Spain: Lechler S.A. · Avda. Pirineos 7 · Oficina B7, Edificio Inbisa I · 28700 San Sebastián de los Reyes, Madrid · Phone: +34 91 6586346 · Fax: +34 91 6586347 · info@lechler.es

USA: Lechler Inc. · 445 Kautz Road · St. Charles, IL, 60174 · Phone: +1 630 3776611 · Fax: +1 630 3776657 · info@lechlerUSA.com